

TRAFFIC IMPACT STUDY

For

Princeton Executive Park Proposed Mixed Use Development

Property Located at:

Meadow Road, Old Meadow Road, Carnegie Center Drive & US Route 1
Block 9 – Lots 12.01 & 12.02
Block 9.03, Lot 12.02
Township of West Windsor, Mercer County, NJ

Prepared by:

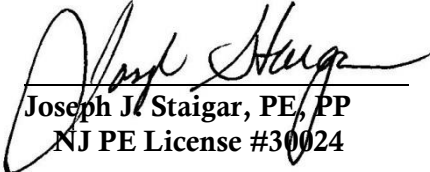

1904 Main Street | 245 Main Street, Suite #110
Lake Como, NJ 07719 | Chester, NJ 07930
(732) 681-0760

Joseph J. Staigar, PE, PP
NJ PE License #30024

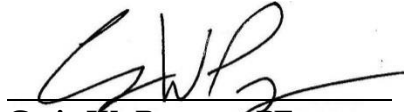
Craig W. Peregoy, PE
NJ PE License #45880

October 29, 2019

1096-99-002TE

INTRODUCTION

It is proposed to construct a mixed use development on two parcels of land on the north and south sides of Meadow Road, east of US Route 1 in the Township of West Windsor, Mercer County, New Jersey, see Figure 1 in Appendix A. Specifically, the development will consist of the following (The Project):

- North of Meadow Road (North Parcel)
 - 130 Room Hotel
 - 6,915 Square Foot Restaurant
 - 16,000 Square Feet of Retail Space
 - 356 Multi-Family Residential Units
- South of Meadow Road (South Parcel)
 - 300 Multi-Family Residential Units

The north parcel is designated as Block 9 – Lot 12.01 and the south parcel is designated as Block 9.03 – Lot 12.02 on the Township of West Windsor Tax Maps. Block 9 – Lot 12.03 is also included as part of the subject property but will remain undeveloped as it is within a recorded “greenbelt”. The two (2) parcels that will be developed are currently vacant. The site is located within the PNM-1 – Planned Mixed Use Neighborhood Zone. Access to the north parcel is proposed via two (2) full –movement driveways along Carnegie Center Drive and one (1) full-movement driveway along Meadow Road. Access to the south parcel is proposed via Meadow Road, opposite Meadow Road Connector by creating a new roundabout intersection, as well as via one (1) full-movement driveway along Old Meadow Road.

Dynamic Traffic LLC has been retained to prepare this study to assess the traffic impact associated with the construction of The Project on the adjacent roadway network. This study documents the methodology, analyses, findings and conclusions of our study and includes:

- A detailed field inspection was conducted to obtain an inventory of existing roadway geometry, traffic control, and location and geometry of existing driveways and intersections.
- Existing traffic data was collected via manual turning movement (MTM) counts during the weekday AM and weekday PM peak periods at the intersections of:
 - Meadow Road and the US Route 1 SB Ramps
 - Meadow Road, Old Meadow Road and the US Route 1 NB Ramps
 - Meadow Road and Meadow Road Connector
 - Meadow Road and Bear Brook Road
 - Meadow Road Connector and Carnegie Center Drive
 - Carnegie Center Drive and three (3) existing office driveways
 - Old Meadow Road and “The Square at West Windsor” shopping center driveway
- Automatic traffic recorder (ATR) counts were performed along Carnegie Center Drive and the US Route 1 NB Ramp for a period of seven (7) days.

- Projections of traffic to be generated by the proposed development were prepared utilizing trip generation data as published by the Institute of Transportation Engineers. Site traffic was then assigned to the adjacent street system based upon the anticipated directional distribution.
- Capacity analyses were conducted for the Existing, No Build, and Build conditions for the study intersections.
- The proposed points of ingress and egress were inspected for adequacy of geometric design, spacing and/or alignment to streets and driveways on the opposite side of the street, relationship to other driveways adjacent to the development, and conformance with accepted design standards.
- The site plan as designed was reviewed for sufficiency in accommodating large wheel base vehicles such as delivery trucks, refuse trucks, and emergency vehicles.
- The parking layout and supply was assessed based on accepted design standards, local requirements, and demand experienced at similar developments.

EXISTING CONDITIONS

A review of the existing roadway conditions near the proposed site was conducted to provide the basis for assessing the traffic impact of the development. This included field investigations of the surrounding roadways and intersections, collection of traffic volume data, and extensive analyses.

Existing Roadway Conditions

The following are descriptions of the roadways in the study area:

Meadow Road is an Urban Major Collector roadway under municipal jurisdiction with a general east/west orientation. In the vicinity of the site the posted speed limit is 25 MPH and the roadway provides one travel lane in each direction to the east and two (2) travel lanes in each direction to the west. On-street parking is not permitted and there is no curb or sidewalk along either side of the roadway. Meadow Road provides a relatively flat vertical alignment and a curved horizontal alignment along the site frontages. West of the site exists an interchange where Meadow Road traverses over US Route 1 before its westerly terminus at Canal Pointe Boulevard.

Meadow Road Connector is an Urban Major Collector roadway under municipal jurisdiction with a general north/south orientation. The roadway extends for approximately 500' between its intersections with Meadow Road and Carnegie Center Drive. Two lanes of travel are provided in each direction and there is no curb or sidewalk along either side of the roadway. The regulatory speed limit is 25 MPH.

Old Meadow Road is a local roadway under municipal jurisdiction providing one lane for each direction of travel. The roadway extends approximately 2,000 feet from its intersection with Meadow Road, opposite the US Route 1 NB Ramps to its easterly terminus as a dead end roadway. Emergency access is provided from its easterly terminus to Meadow Road. Old Meadow Road serves as an access roadway to multiple developments to the south including "The Square at West Windsor" shopping center and the "Windsor Woods" residential development. Sidewalk is provided along the southerly side of the roadway and curb is provided for portions of the southerly side of the roadway. No curb or sidewalk is provided along the northerly side of the roadway.

Carnegie Center Drive is an Urban Major Collector roadway along the site frontage and is under municipal jurisdiction. The roadway serves as a "ring road" around a large office complex. In the vicinity of the site the posted speed limit is 25 MPH and the roadway provides one travel lane and one bike lane in each direction. On-street parking is not permitted. Curb is provided only along the north side of the roadway and sidewalk is not provided on either side of the roadway. Left-turn lanes are provided at driveways for the adjacent office buildings to the north.

Bear Brook Road is an Urban Minor Collector roadway under municipal jurisdiction with a general north/south orientation. In the vicinity of Meadow Road, the posted speed limit is 25 MPH and the roadway provides one travel lane in each direction separated by a grass median. On-street parking is not permitted and curb and sidewalk are provided along the east side of the roadway. The land uses along Bear Brook Road are primarily residential. The roadway provides access from Meadow Road to the south to Alexander Road to the north.

Existing Traffic Volumes

Manual turning movement (MTM) counts were conducted on Thursday, May 9, 2019 from 7:00 to 9:00 AM and from 4:30 to 6:30 PM at the following intersections:

- Meadow Road and the US Route 1 SB Ramps
- Meadow Road, Old Meadow Road and the US Route 1 NB Ramps
- Meadow Road and Meadow Road Connector
- Meadow Road and Bear Brook Road
- Meadow Road Connector and Carnegie Center Drive
- Carnegie Center Drive and three (3) existing office driveways
- Old Meadow Road and “The Square at West Windsor” shopping center driveway

In addition, automatic traffic recorder (ATR) counts were conducted along Carnegie Center Drive and the Route 1 NB ramp from Tuesday, September 17, 2019 to Monday, September 23, 2019.

Review of the collected traffic data reveals that the weekday morning peak street hour (PSH) occurs between 8:00 - 9:00 AM, the weekday evening PSH occurs between 4:45 - 5:45 PM. Where necessary, traffic volumes were balanced between intersections with the higher through volume governing. Figure 2, located in Appendix A, shows the existing peak hour traffic volumes at the study intersections. All traffic counts are contained in Appendix B.

Existing Capacity Analysis

The methodology utilized in the capacity analyses is described in the *Highway Capacity Manual*, published by the Transportation Research Board. In general, the term Level of Service (LOS) is used to provide a “qualitative” evaluation of capacity based upon certain “quantitative” calculations related to empirical values, such as traffic volume and intersection control.

At the signalized intersections, factors that affect the various approach capacities include width of approach, number of lanes, signal “green time”, turning percentages, truck volumes, etc. However, delays cannot be related to capacity in a simple one-to-one fashion. For example, it is possible to have delays in the Level of Service “F” range without exceeding roadway capacity. Substantial delays can exist without exceeding capacity if one or more of the following conditions exist: long signal cycle lengths; a particular traffic movement experiences a long red time; or progressive movement for a particular lane group is poor. Table I describes the level of service ranges for signalized intersections.

An unsignalized (STOP sign controlled) driveway or side street along a through route is seldom critical from an overall capacity standpoint, however, it may be of great significance to the capacity of the minor cross-route, and it may influence the quality of traffic flow on both. When analyzing an unsignalized intersection, it is assumed that both the major street through and right turn movements are unimpeded and have the right-of-way over all side street traffic and left turns from the major street. All other turning movements in the intersection cross, merge with, or are otherwise impeded by major street movements. Traffic delays at unsignalized intersections are determined by sequentially processing these impeded movements. Table II describes the level of service ranges for unsignalized (stop controlled) intersections.

Table I
Level of Service Criteria
for Signalized Intersections

Level of Service	Average Control Delay (seconds per vehicle)
A	0.0 to 10.0
B	10.1 to 20.0
C	20.1 to 35.0
D	35.1 to 55.0
E	55.1 to 80.0
F	greater than 80.0

Table II
Level of Service Criteria
for Unsignalized Intersections

Level of Service	Average Control Delay (seconds per vehicle)
a	0.0 to 10.0
b	10.1 to 15.0
c	15.1 to 25.0
d	25.1 to 35.0
e	35.1 to 50.0
f	greater than 50.0

All capacity analyses were performed utilizing Synchro 10 software. Tables III and IV summarize the existing levels of service (LOS) and delays. All capacity analysis calculation worksheets are contained in Appendix C.

Table III
Existing Levels of Service - Signalized

Signalized Intersection	Direction/ Movement		Morning Peak Hour		Evening Peak Hour	
			LOS	Delay (s/veh)	LOS	Delay (s/veh)
Meadow Road & Route 1 SB Ramps	EB	L	A	2.6	A	4.1
		T	A	3.3	A	4.2
	WB	T	A	6.2	A	9.1
		R	A	0.5	A	2
	SB	L	C	33.7	C	34.9
		R	B	18.1	B	14.6
Overall			A	5.4	A	6.3
Old Meadow Road, Route 1 NB Ramps & Meadow Road	EB	L	A	6.9	A	7.9
		TR	A	9.8	B	12.9
	WB	L	A	6.8	A	7.9
		T	B	12.1	B	45.6
	NB	R	A	0.6	A	0.8
		L	C	27.1	C	30.7
	SB	TR	C	22	C	20.3
		L	D	39.9	E	59.1
	T	D	40.5	D	43.3	
	R	A	0.5	A	0.7	
Overall			A	9.7	B	15.1
Meadow Road & Bear Brook Road	EB	L	A	4.3	A	6.3
		T	A	3.4	A	6.4
	WB	T	A	4.6	A	4.2
		R	A	0.1	A	0.1
	SB	L	C	30.4	C	33.9
		R	B	11.1	A	8.7
Overall			A	6.9	A	8.4

**Table IV
Existing Levels of Service - Unsignalized**

Unsignalized Intersection	Direction/ Movement		Morning Peak Hour		Evening Peak Hour	
			LOS	Delay (s/veh)	LOS	Delay (s/veh)
Rt 1 Rmp & Carnegie Ctr Dr	NB	R	B	12	A	9.1
Meadow Road & Meadow Road Connector	EB	L	A	9.6	A	8
	SB	L	C	18.5	F	91.9
		R	B	11.6	D	29.2
Meadow Road Connector & Carnegie Center Drive	NB	L	A	7.5	A	8.9
	EB	L	D	27.2	C	16.1
		R	A	8.6	C	23.1
Carnegie Center Drive & East Office Driveway	EB	L	A	7.6	A	7.4
	SB	LR	B	11.6	B	10.2
Carnegie Center Drive & Middle Office Driveway	EB	L	A	7.5	A	7.3
	SB	LR	B	10.8	B	10.3
Carnegie Center Drive & West Office Driveway	EB	L	A	7.7	A	7.4
	SB	LR	B	11.9	B	10
Shopping Center Driveway & Old Meadow Road	WB	L	A	7.4	A	7.7
	NB	L	A	9.1	B	10.4
		R	A	8.4	A	8.6

The following are discussions pertaining to each of the existing intersections analyzed. It should be noted that the existing percentage of trucks and peak hour factors were used in the existing analysis.

Meadow Road & Route 1 SB Ramps

Ramps to/from southbound Route 1 intersect Meadow Road from the north to form a three-leg intersection controlled by a traffic signal. The signal timing directive was obtained from the New Jersey Department of Transportation which indicates that the signal operates with three (3) phases including an eastbound left-turn lead phase.

The eastbound Meadow Road approach to the intersection provides an exclusive left-turn lane and a through lane. The westbound Meadow Road approach provides two (2) through lanes and a channelized right turn lane. The southbound approach of the Route 1 southbound off ramp provides a double left-turn lane and an exclusive right-turn lane. A pedestrian crosswalk is provided across the eastbound leg of the intersection.

A review of the existing analysis reveals that movements at the intersection operate at level of service “C” or better during the analyzed peak periods. See Table III for the individual movement levels of service and delays.

Meadow Road, Old Meadow Road & Route 1 NB Ramps

Old Meadow Road intersects Meadow Road from the south, opposite ramps to/from northbound Route 1. The signal timing directive was obtained from the New Jersey Department of Transportation

which indicates that a four phase operation is utilized inclusive of lead left-turn phases for all approaches.

The eastbound Meadow Road approach provides an exclusive left-turn lane, a through lane and a shared through/right-turn lane. The westbound Meadow Road approach provides an exclusive left-turn lane, two through lanes and a channelized right-turn lane. The northbound Old Meadow Road approach to the intersection provides an exclusive left-turn lane and a shared through/right-turn lane. The southbound Route 1 ramp approach to the intersection provides an exclusive left-turn lane, a through lane and a channelized right-turn lane. A pedestrian crosswalk is provided across the eastbound leg of the intersection.

A review of the existing analysis reveals that the intersection operates at overall level of service “B” or better and all movements operate at levels of service “D” or better during the analyzed peak periods with the exception of the southbound left-turn movement which operates at level of service “E” during the weekday evening peak hour. See Table III for the individual movement levels of service and delays.

Meadow Road & Bear Brook Road

Bear Brook Road intersects Meadow Road from the north to form a three-leg intersection controlled by a traffic signal. The signal timing directive indicates that a two-phase operation is utilized inclusive of a right-turn overlap phase for westbound Meadow Road.

The eastbound Meadow Road approach includes an exclusive left-turn lane, a through lane and a bike lane. The westbound Meadow Road approach includes a through lane, a bike lane and an exclusive right-turn lane. The southbound Bear Brook Road approach includes separate left-turn and right-turn lanes. Pedestrian crosswalks are provided across the eastbound and southbound approaches to the intersection.

A review of the existing analysis reveals that movements at the intersection operate at level of service “C” or better during the analyzed peak periods. See Table III for the individual movement levels of service and delays.

Route 1 NB Ramp & Carnegie Center Drive

A ramp from northbound Route 1 merges with Carnegie Center Drive in the northwest corner of the north parcel. This intersection was conservatively analyzed as a two-way stop controlled intersection although movements from Route 1 are yield controlled.

A review of the existing analysis reveals that the intersection operates at level of service “B” or better during the analyzed peak periods. See Table IV for the individual movement levels of service and delays.

Meadow Road & Meadow Road Connector

Meadow Road Connector intersects Meadow Road from the north to form a three-leg intersection controlled by a STOP sign on the Meadow Road Connector. The eastbound Meadow Road approach includes an exclusive left-turn lane, a through lane and a bike lane. The westbound Meadow Road

approach includes a through lane, a bike lane and an exclusive right-turn lane. The southbound Meadow Road Connector approach includes separate left-turn and right-turn lanes.

A review of the existing analysis reveals that all movements operate at levels of service “D” or better during the analyzed peak periods with the exception of the southbound left-turn movement which operates at level of service “F” during the weekday evening peak hour, likely a result of the volume of traffic exiting the office complex at the end of the work day. See Table IV for the individual movement levels of service and delays.

Meadow Road Connector & Carnegie Center Drive

Carnegie Center Drive intersects the Meadow Road Connector from the west to form a three-leg intersection controlled by a STOP sign on the eastbound Carnegie Center Drive approach. It is noted that the southbound approach or, northerly leg of the intersection, is considered Carnegie Center Drive although it is physically a continuation of Meadow Road Connector.

A review of the existing analysis reveals that the all movements operate at levels of service “D” or better during the analyzed peak periods. See Table IV for the individual movement levels of service and delays.

Carnegie Center Drive & Office Driveways

The three (3) office driveways studied each intersect Carnegie Center Drive from the north and are all controlled by STOP signs on the respective driveway approaches. A left-turn lane is provided for ingress to each driveway along Carnegie Center Drive and a single lane is provided for egress.

A review of the existing analysis reveals that movements at each driveway operate at levels of service “B” or better during the analyzed peak periods. See Table IV for the individual movement levels of service and delays.

Old Meadow Road & Shopping Center Driveway

A driveway for “The Square at West Windsor” shopping center intersects Old Meadow Road from the south to form a three-leg unsignalized intersection controlled by a STOP sign on the driveway approach to the intersection. The driveway provides separate left and right turn lanes for egress.

A review of the existing analysis reveals that movements at each driveway operate at levels of service “B” or better during the analyzed peak periods. See Table IV for the individual movement levels of service and delays.

FUTURE CONDITIONS

Traffic volumes and operational analyses were developed for both the No Build and Build conditions. The No Build conditions provide a baseline for assessing the impact of the site development traffic on the roadway system. The process of developing the No Build and Build traffic volumes and the subsequent analyses is outlined below.

Regardless of whether the subject site is developed or not, traffic volumes on the surrounding roadways are expected to increase as a result of developments throughout the region. A growth rate for roadways within the study area was obtained from the NJDOT Annual Background Growth Rate Table, which indicates a growth rate of 1.0% per year.

Through consultation with the Township of West Windsor Planning Board staff, there are no other developments in the vicinity of the site that have been approved but not yet constructed that are identified as significant traffic generators. It was assumed that the background growth rate was adequate to account for the traffic associated with all developments not listed.

Future No Build traffic volumes were developed by applying the background growth rate of 1.0% for four (4) years to the study area roadways existing traffic volumes. Figure 3, in Appendix A, shows the No Build traffic volumes.

Traffic Generation

Trip generation projections for The Project were prepared utilizing trip generation research data as published in the Institute of Transportation Engineers' (ITE) publication, *Trip Generation, 10th Edition*. This publication sets forth trip generation rates based on traffic counts conducted at research sites throughout the country. The following Land Use Codes (LUC) and associated independent variables were utilized for the trip generation projections:

- LUC 310 – Hotel – 130 Rooms
- LUC 932 – High-Turnover Sit Down Restaurant – 6,915 Square Feet
- LUC 820 – Shopping Center – 16,000 Square Feet
- LUC 221 – Multi-Family Housing (Mid Rise) – 356 Dwelling Units (North Parcel)
- LUC 221 – Multi-Family Housing (Mid Rise) – 300 Dwelling Units (South Parcel)

It should be noted that the description for LUC 310 indicates that restaurants are included within the trip generation research for some of the hotels that contained an attached or internal restaurant. Therefore, the use of LUC 932 to separately project the restaurant trip generation is somewhat conservative.

The ITE publication *Trip Generation Handbook*, recognizes that when land uses are proximate to each other, individual land uses tend to interact, reducing the overall trip generation for the site. It is anticipated that there will be an overall reduction in site generated trips due to the opportunities for users to visit a combination of the hotel, residential, restaurant and retail uses. These trips can be made without accessing the regional roadway network and are considered “internal” to the overall development. Based on the ITE internal capture methodology, reduction rates of 8.9% and 25.0% have been applied to site generated trips during the weekday morning and weekday evening peak hours, respectively, to account for this effect. All internal capture calculation worksheets are

contained in Appendix D. It should be noted that internally captured traffic volumes associated with the south parcel were considered in the analysis and routed to cross Meadow Road as vehicular trips even though these vehicular trips will likely be frequently replaced with pedestrian trips across Meadow Road.

According to studies conducted by ITE, traffic associated with LUC 820 and LUC 932 is not 100% newly generated. Rather, a portion of the traffic is diverted from the existing traffic stream on the adjacent roadway network. This is because the retail and restaurant uses are not exclusively destination land uses, instead patrons stop on their way to/from other locations such as home or work. ITE identifies a 34% passby traffic percentage for LUC 820 and 43% passby traffic percentage for LUC 932, which are also accepted by NJDOT, and were used during the evening peak hour. It should be noted that there will realistically be passby traffic during the weekday morning peak periods as well even though there is no data published by ITE or NJDOT. However, conservatively, no credit was taken for this effect. Table V below details the traffic volumes associated with the subject project taking into account internal capture and the passby credits. Trip Generation calculations are contained in Appendix D.

**Table V
Trip Generation Considering Passby Traffic**

Trip Type		AM PSH			PM PSH		
		In	Out	Total	In	Out	Total
Princeton Executive Park	Total	144	237	381	326	249	575
	Internal	17	17	34	72	72	144
	Passby	0	0	0	21	21	42
	New (Primary)	127	220	347	233	156	389

Once the magnitude of traffic to be generated by the site is known, it is necessary to assign that traffic to the adjacent street system. The distribution of new traffic to the surrounding roadways is based on the location of primary arterial roadways, major signalized intersections and existing traffic patterns. Table VI below summarizes the anticipated trip distribution for The Project.

**Table VI
Trip Distribution**

To/From	Percentage
Route 1 North	54%
Route 1 South	28%
Meadow Road East	10%
Meadow Road West	8%
Total	100%

Located in Appendix A, the following Figures illustrate the site generated traffic volumes;

- Figure 4 – Hotel Site Generated Traffic
- Figure 5 – North Residential Site Generated Traffic
- Figure 6 – South Residential Site Generated Traffic
- Figure 7 – Commercial (Retail/Restaurant) Primary Site Generated Trips
- Figure 8 - Commercial (Retail/Restaurant) Passby Site Generated Trips
- Figure 9 – Total Site Generated Traffic Volumes

The site generated volumes were added to the No Build traffic volumes to generate the Build traffic volumes, which are shown in Figure 10.

Future Capacity Analysis

Operational conditions at the study intersections were analyzed under the No Build and Build conditions and are summarized in Tables VII through X below.

**Table VII
Future No Build Levels of Service – Signalized**

Signalized Intersection	Direction/ Movement		Morning Peak Hour		Evening Peak Hour	
			LOS	Delay (s/veh)	LOS	Delay (s/veh)
Meadow Road & Route 1 SB Ramps	EB	L	A	2.6	A	4.3
		T	A	3.3	A	4.3
	WB	T	A	6.9	A	9.3
		R	A	0.5	A	2.2
	SB	L	C	33.7	D	35
		R	B	18.1	B	14.3
Overall			A	5.7	A	6.5
Old Meadow Road, Route 1 NB Ramps & Meadow Road	EB	L	A	7	A	8
		TR	A	9.9	B	13.2
	WB	L	A	6.9	A	8
		T	B	12.2	B	15.9
		R	A	0.8	A	1
	NB	L	C	27.2	C	30.9
		TR	C	22.1	C	20.3
	SB	L	D	40.2	E	61.9
		T	D	40.5	D	43.4
		R	A	0.6	A	0.7
Overall			A	9.8	B	15.5
Meadow Road & Bear Brook Road	EB	L	A	4.5	A	6.6
		T	A	3.4	A	6.7
	WB	T	A	4.8	A	4.4
		R	A	0.1	A	0.1
	SB	L	C	30.6	C	34.1
		R	B	11.2	A	8.6
Overall			A	7	A	8.6

**Table VIII
Future No Build Levels of Service – Unsignalized**

Unsignalized Intersection	Direction/ Movement		Morning Peak Hour		Evening Peak Hour	
			LOS	Delay (s/veh)	LOS	Delay (s/veh)
Rt 1 Rmp & Carnegie Ctr Dr	NB	R	B	12.3	A	9.1
Meadow Road & Meadow Road Connector	EB	L	A	9.8	A	8.1
	SB	L	C	19.4	F	123.8
		R	B	11.8	E	35.1
Meadow Road Connector & Carnegie Center Drive	NB	L	A	7.6	A	9.1
	EB	L	D	31.4	C	16.8
		R	A	8.6	D	25.9
Carnegie Center Drive & East Office Driveway	EB	L	A	7.6	A	7.4
	SB	LR	B	11.8	B	10.3
Carnegie Center Drive & Middle Office Driveway	EB	L	A	7.5	A	7.3
	SB	LR	B	10.9	B	10.4
Carnegie Center Drive & West Office Driveway	EB	L	A	7.7	A	7.4
	SB	LR	B	12.2	B	10.1
Shopping Center Driveway & Old Meadow Road	WB	L	A	7.4	A	7.7
	NB	L	A	9.1	B	10.5
		R	A	8.4	A	8.6

**Table IX
Future Build Levels of Service – Signalized**

Signalized Intersection	Direction/ Movement		Morning Peak Hour		Evening Peak Hour	
			LOS	Delay (s/veh)	LOS	Delay (s/veh)
Meadow Road & Route 1 SB Ramps	EB	L	A	2.9	A	5.2
		T	A	3.7	A	5.2
	WB	T	A	7.7	B	10.6
		R	A	0.6	A	2.5
	SB	L	D	35.5	D	37.3
		R	B	17.8	B	13.3
	Overall		A	7.3	A	8.7
Old Meadow Road, Route 1 NB Ramps & Meadow Road	EB	L	A	7.3	A	8.5
		TR	B	11	B	15.2
	WB	L	A	7.2	A	8.7
		T	B	12.9	B	16.7
		R	A	2.8	A	3.1
	NB	L	C	7.4	C	31.5
		TR	C	28.1	C	24.9
	SB	L	D	40.6	D	54.9
		T	D	41.2	D	43.7
		R	A	0.6	A	0.7
Overall		B	10.7	B	15.9	
Meadow Road & Bear Brook Road	EB	L	A	4.6	A	6.8
		T	A	3.5	A	6.9
	WB	T	A	4.9	A	4.4
		R	A	0.1	A	0.1
	SB	L	C	30.5	C	34.1
		R	B	11.2	A	8.6
Overall		A	7	A	8.6	

**Table X
Future Build Levels of Service – Unsignalized**

Unsignalized Intersection	Direction/ Movement		Morning Peak Hour		Evening Peak Hour	
			LOS	Delay (s/veh)	LOS	Delay (s/veh)
Rt 1 Rmp & Carnegie Ctr Dr	NB	R	B	12.7	A	9.3
Meadow Road & Meadow Road Connector	EB	L	A	4.9	B	11.6
	WB	LTR	A	6.3	A	4.9
	NB	LTR	A	4.4	A	7.9
	SB	L	A	4.6	B	10.6
R						
Meadow Road Connector & Carnegie Center Drive	NB	L	A	7.6	A	9.1
	EB	L	D	34.3	C	17.5
		R	A	8.7	D	26.7
Carnegie Center Drive & East Office Driveway	EB	L	A	7.6	A	7.4
	WB	L	A	8	A	7.8
	NB	LR	B	10.4	A	9.6
	SB	LR	B	12.7	B	10.8
Carnegie Center Drive & Middle Office Driveway	EB	L	A	7.5	A	7.3
	SB	LR	B	11	B	10.5
Carnegie Center Drive & West Office Driveway	EB	L	A	7.7	A	7.4
	WB	L	A	8.4	A	7.7
	NB	LR	C	18.1	B	10.4
	SB	LR	B	13.3	B	10.7
Shopping Center Driveway & Old Meadow Road	WB	L	A	7.4	A	7.8
	NB	L	A	9.4	B	11
		R	A	8.4	A	8.7
Site Driveway & Meadow Road	EB	L	A	8.9	B	11.3
	SB	LR	B	12.4	D	32.7
Site Driveway & Old Meadow Road	EB	L	A	7.4	A	7.4
	SB	LR	A	9	A	8.7

Meadow Road & Route 1 SB Ramps

With the addition of site generated traffic, the intersection is anticipated to operate at overall intersection level of service “A” during the analyzed peak hours. Additionally, each movement is anticipated to operate at acceptable levels of service “D” or better. See Tables VII and IX for the individual movement levels of service and delays.

Meadow Road, Old Meadow Road & Route 1 NB Ramps

With the addition of site generated traffic, the intersection is anticipated to operate at overall intersection level of service “B” or better during the analyzed peak hours. Additionally, each movement is anticipated to operate at levels of service “D” or better. In fact, the additional

southbound traffic generated by the south residential parcel results in more green time given to the north/south signal phase which slightly reduces the delay for the most constrained southbound left-turn movement. Additionally, it should be noted that this intersection will be modified to accommodate a pedestrian crossing of the southbound approach to the intersection which will provide a connection between the north parcel and the sidewalk on the south side of Old Meadow Road which serves the shopping center and adjacent residential development. See Tables VII and IX for the individual movement levels of service and delays.

Meadow Road & Bear Brook Road

With the addition of site generated traffic, the intersection is anticipated to operate at overall intersection level of service “A” during the analyzed peak hours. Additionally, each movement is anticipated to operate at levels of service “C” or better. See Tables VII and IX for the individual movement levels of service and delays.

Route 1 NB Ramp & Carnegie Center Drive

With the addition of site generated traffic, the intersection is anticipated to continue to operate at levels of service “B” or better during the analyzed peak hours. See Tables VIII and X for the individual movement levels of service and delays.

Meadow Road & Meadow Road Connector/South Parcel Driveway

A driveway to the south parcel is proposed as the fourth leg to the Meadow Road Connector intersection with Meadow Road. Additionally, the intersection will be modified to a roundabout intersection with the eastbound, westbound and southbound approaches providing a right-turn lane and a through lane into the interior circulating lane. The northbound driveway approach will provide one lane for all movements.

With the addition of site generated traffic and the improvements described above, movements at the roundabout are anticipated to operate at levels of service “B” or better during the analyzed peak hours. This represents a substantial improvement to the no build condition which results in southbound lefts operating at level of service “F” and southbound right-turn movements operating levels of service “E”. See Tables VIII and X for the individual movement levels of service and delays.

Meadow Road Connector & Carnegie Center Drive

With the addition of site generated traffic, movements at the intersection are anticipated to operate at of service “D” or better, maintaining the No Build levels of service. See Tables VIII and X for the individual movement levels of service and delays.

Carnegie Center Drive & Office Driveways/North Parcel Driveways

Site driveways for the north parcel are proposed to intersect Carnegie Center Drive opposite the easterly and westerly office driveways. The median will be restriped to provide opposing left-turn lanes along Carnegie Center Drive for left-turn ingress into the respective driveways.

With the addition of site generated traffic and the introduction of site driveways opposite the existing driveways, these intersection are anticipated to operate at favorable levels of service “C” or better

during the analyzed peak hours. See Tables VIII and X for the individual movement levels of service and delays.

Old Meadow Road & Shopping Center Driveway

With the addition of site generated traffic, movements at the intersection are anticipated to operate at of service “B” or better, maintaining the No Build levels of service. See Tables VIII and X for the individual movement levels of service and delays.

Meadow Road and North Parcel Site Driveway

The site driveway is proposed to intersect Meadow Road from the north to form an unsignalized T-intersection with the southbound approach of the site driveway operating under stop control. Meadow Road is proposed to be restriped within its existing cartway to provide an exclusive left-turn lane and two through lanes in the eastbound direction. The westbound approach of Meadow Road is proposed to provide a through lane and a shared through/right turn lane. The site driveway will provide a single lane for all egress movements.

As designed, the driveway is anticipated to operate at levels of service “D” or better during the studied peak hours. See Table X for the individual movement levels of service and delays.

Old Meadow Road and South Parcel Site Driveway

The site driveway is proposed to intersect Old Meadow Road from the north to form an unsignalized T-intersection with the southbound approach of the site driveway operating under stop control. Both Old Meadow Road approaches as well as the site driveway will provide a single lane for all movements.

As designed, the driveway is anticipated to operate with minimal delay at level of service “A” during the studied peak hours. See Table X for the individual movement levels of service and delays.

As described above, under future Build conditions, all movements within the studied roadway network will operate acceptably at levels of service “D” or better during both peak hours analyzed.

SITE PLAN

Site Access and Circulation

The site plan was reviewed with respect to the site access and on-site circulation design. As noted previously, access to the north parcel will be provided via a new full movement driveway along Meadow Road and via two (2) new full-movement driveways along Carnegie Center Drive which are appropriately located aligned with and opposite existing driveways. Access to the south parcel will be proposed via the new roundabout intersection with Meadow Road and via a full-movement driveway along Old Meadow Road. As evidenced based on the capacity analysis results, this access configuration will serve the properties efficiently and will operate safely and within acceptable ranges of delay.

On-site parking and drive aisles have been designed to provide safe and efficient circulation throughout The Project and are supplemented by ample pedestrian and bicycle amenities to serve the residents, guests and patrons. Review of the site plan design indicates that the site can sufficiently accommodate, within paved areas, a large wheel base vehicle where required, along with the passenger vehicle traffic anticipated.

Parking

The parking requirements pursuant to the Township of West Windsor are as follows:

- Hotel – 1/Room and 0.5/Employee – 208 Required
- Restaurant – 1/3 Seats and 0.5/Employee – 104 Required
- Retail – 5/1000 Square Feet – 80 Required
- Residential – Per Residential Site Improvement Standards (RSIS) – 1,276 Required (692 North – 584 South)
- TOTAL = 1,668 Required

As shown above, 1,668 spaces are required and 1,716 spaces are proposed. Therefore, the parking supply will be more than sufficient to accommodate the maximum anticipated demand.

It is proposed to provide parking stalls with dimensions of 9'x18', which satisfy the Ordinance minimum requirement of 9'x18'. It should be noted that industry standards recommend stall widths of between 8'9" and 9' and a length of 18' for high-turnover land uses such as The Project, which is met as designed.

FINDINGS & CONCLUSIONS

Findings

Based upon the detailed analyses as documented herein, the following findings are noted:

- The proposed mixed use development, will generate 127 entering trips and 220 exiting trips during the weekday morning peak hour and 233 entering trips and 156 exiting trips during the evening peak hour. It should be noted that the “new” weekday morning trips are likely to be lower than that projected since no credit was taken for passby trips.
- Access to the north parcel is proposed via two (2) full –movement driveways along Carnegie Center Drive and one (1) full-movement driveway along Meadow Road.
- Access to the south parcel is proposed via Meadow Road, opposite Meadow Road Connector by creating a new roundabout intersection, as well as via one (1) full-movement driveway along Old Meadow Road.
- With the addition of site generated traffic, all studied intersections are anticipated to operate at acceptable levels of service “D” or better during the peak hours studied.
- As proposed, The Project’s site driveways and internal circulation have been designed to provide for safe and efficient movement of automobiles and large wheel base vehicles.
- The proposed parking supply and design is sufficient to support the projected demand and exceeds the Ordinance requirements.

Conclusions

Based upon our Traffic Impact Study as detailed in the body of this report, it is the professional opinion of Dynamic Traffic LLC that the adjacent street system of the Township of West Windsor, Mercer County and NJDOT will not experience any significant degradation in operating conditions with the construction of The Project. The site driveways are located to provide safe and efficient access to the adjacent roadway system. The site plan as proposed provides for good circulation throughout the site and provides adequate parking to accommodate The Project’s needs.

Technical Appendix

Appendix A
Traffic Volume Figures



Proposed Mixed-Use Development
 Traffic Impact Study
 1096-99-002TE
 10/18/2019

Figure 1

Site Location Map

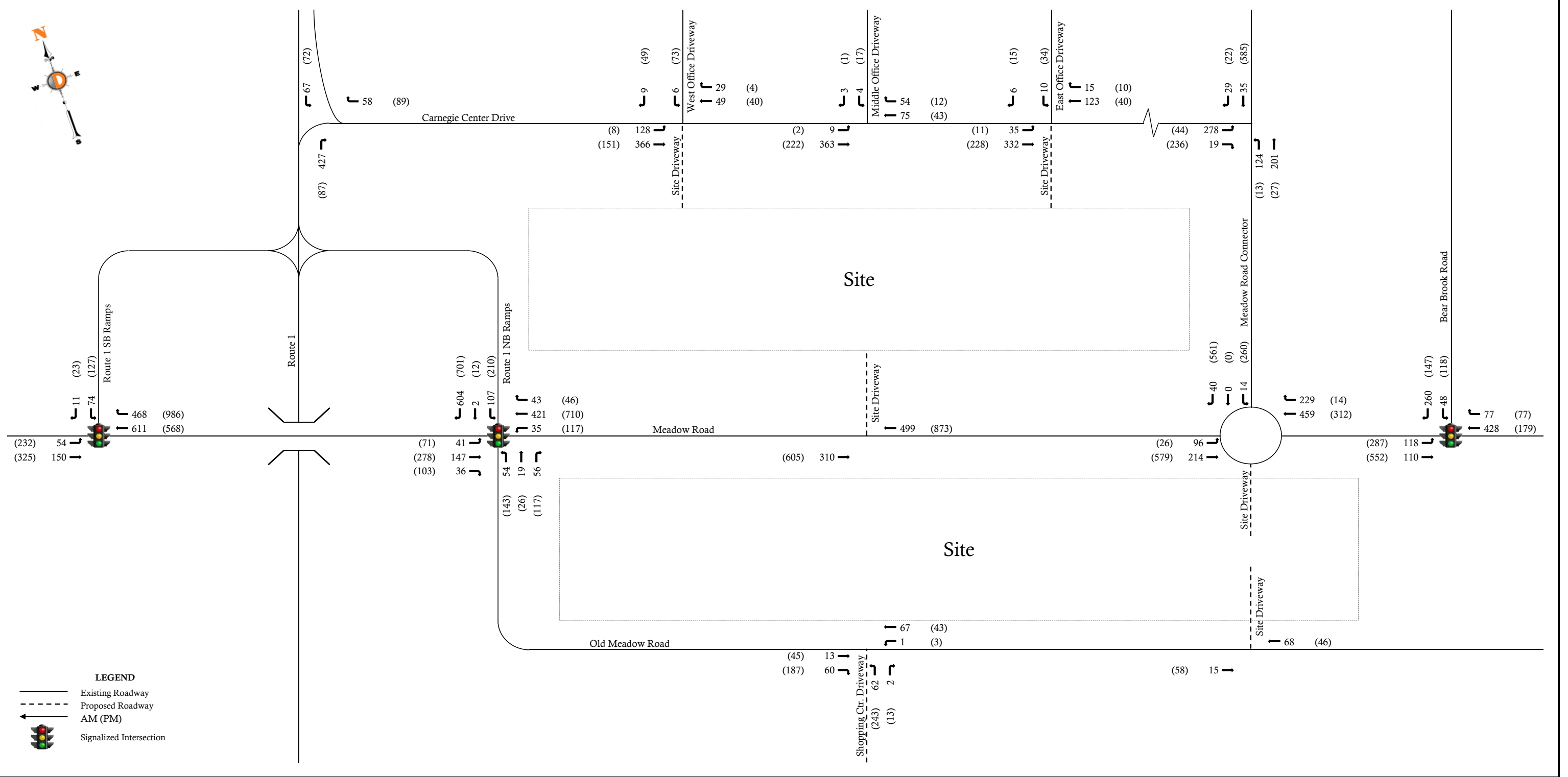

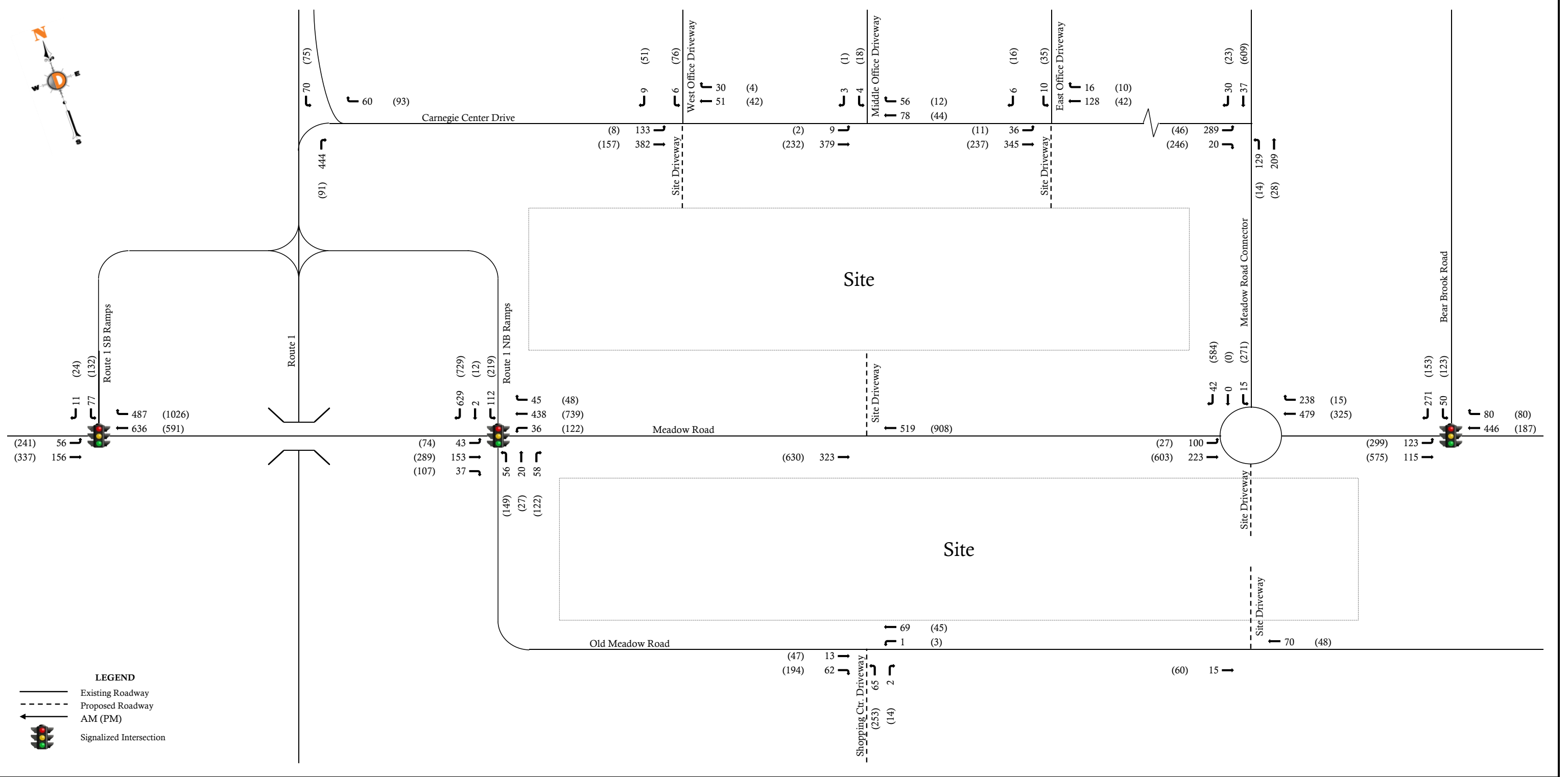

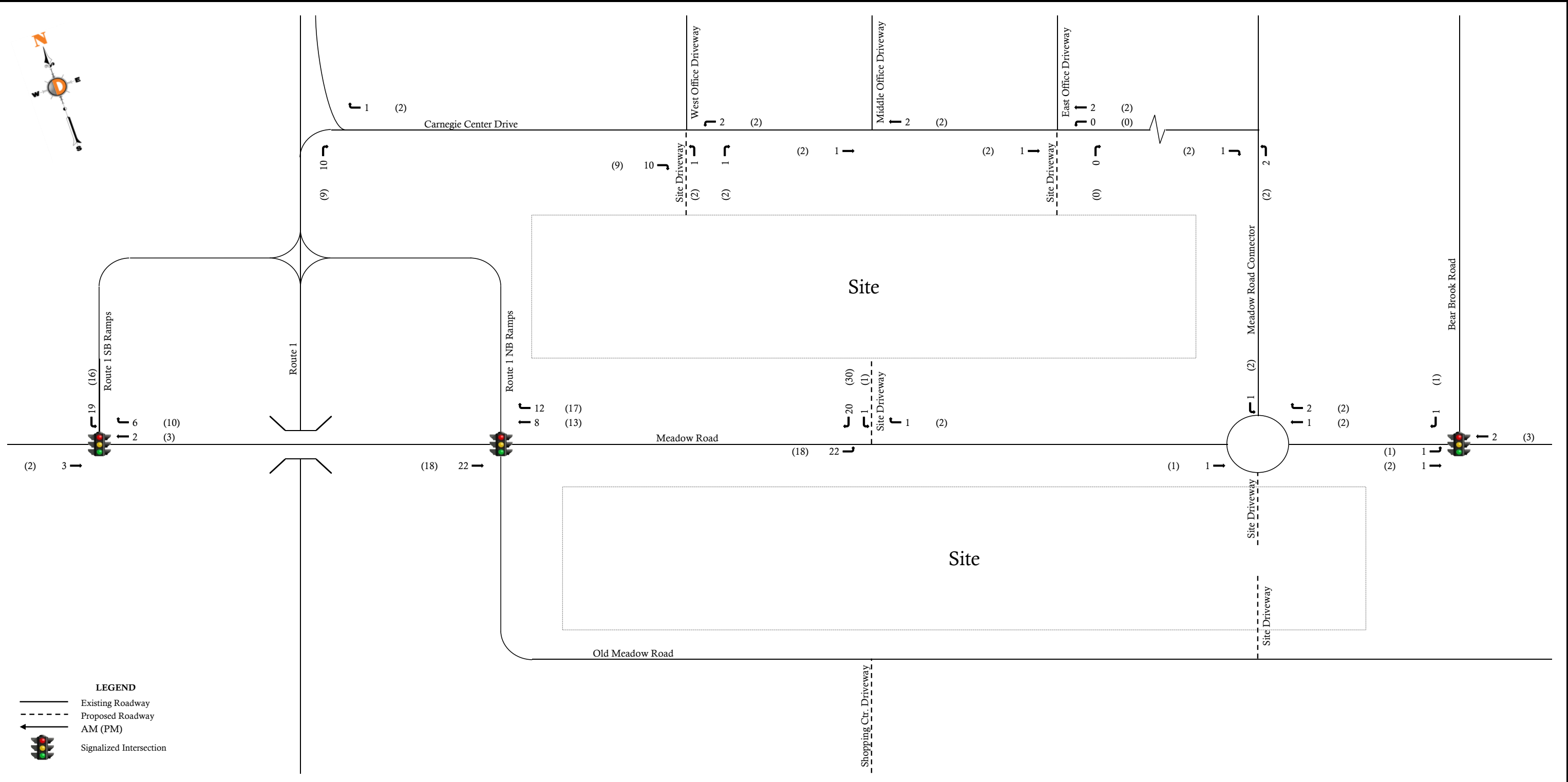

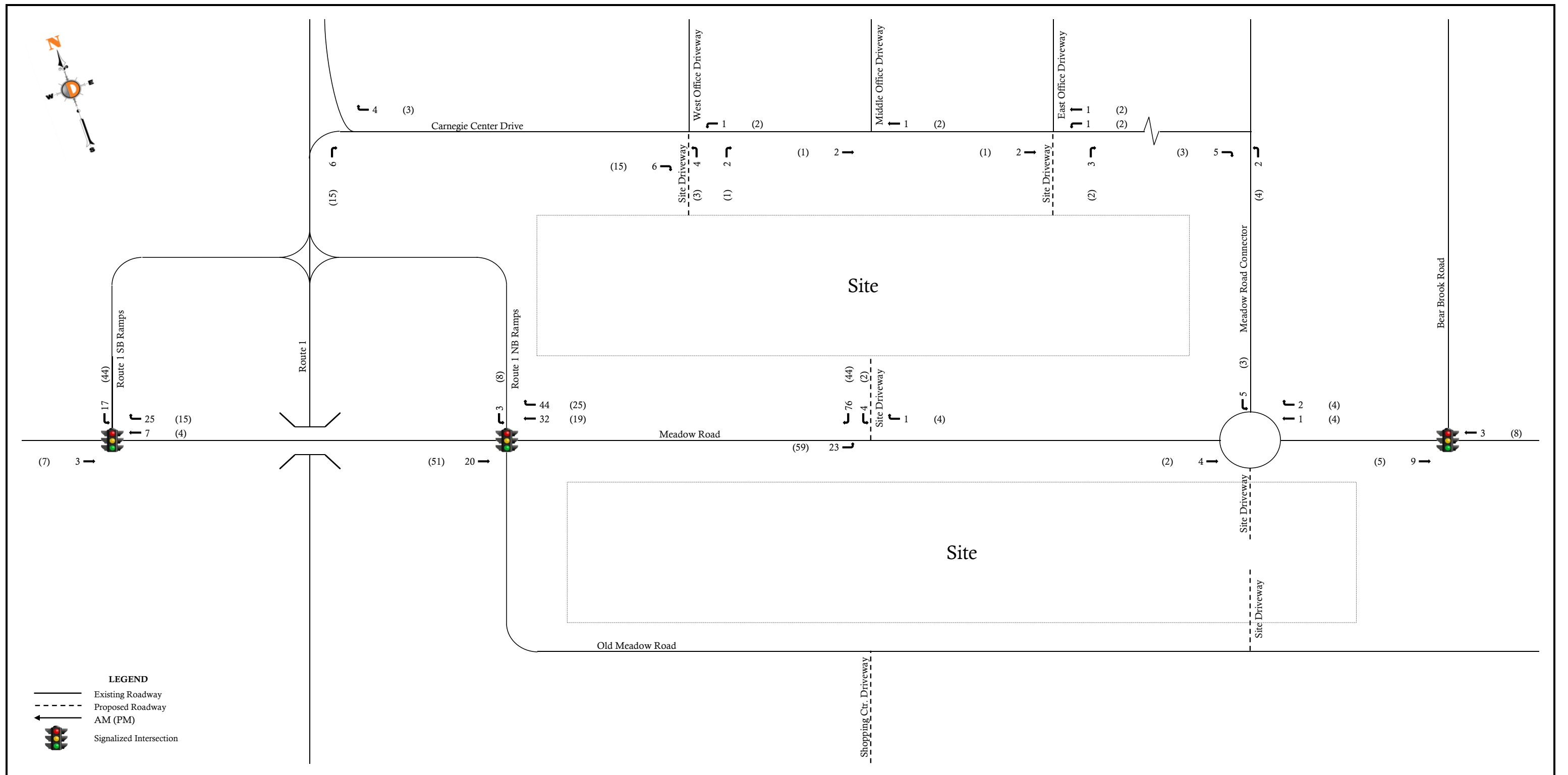

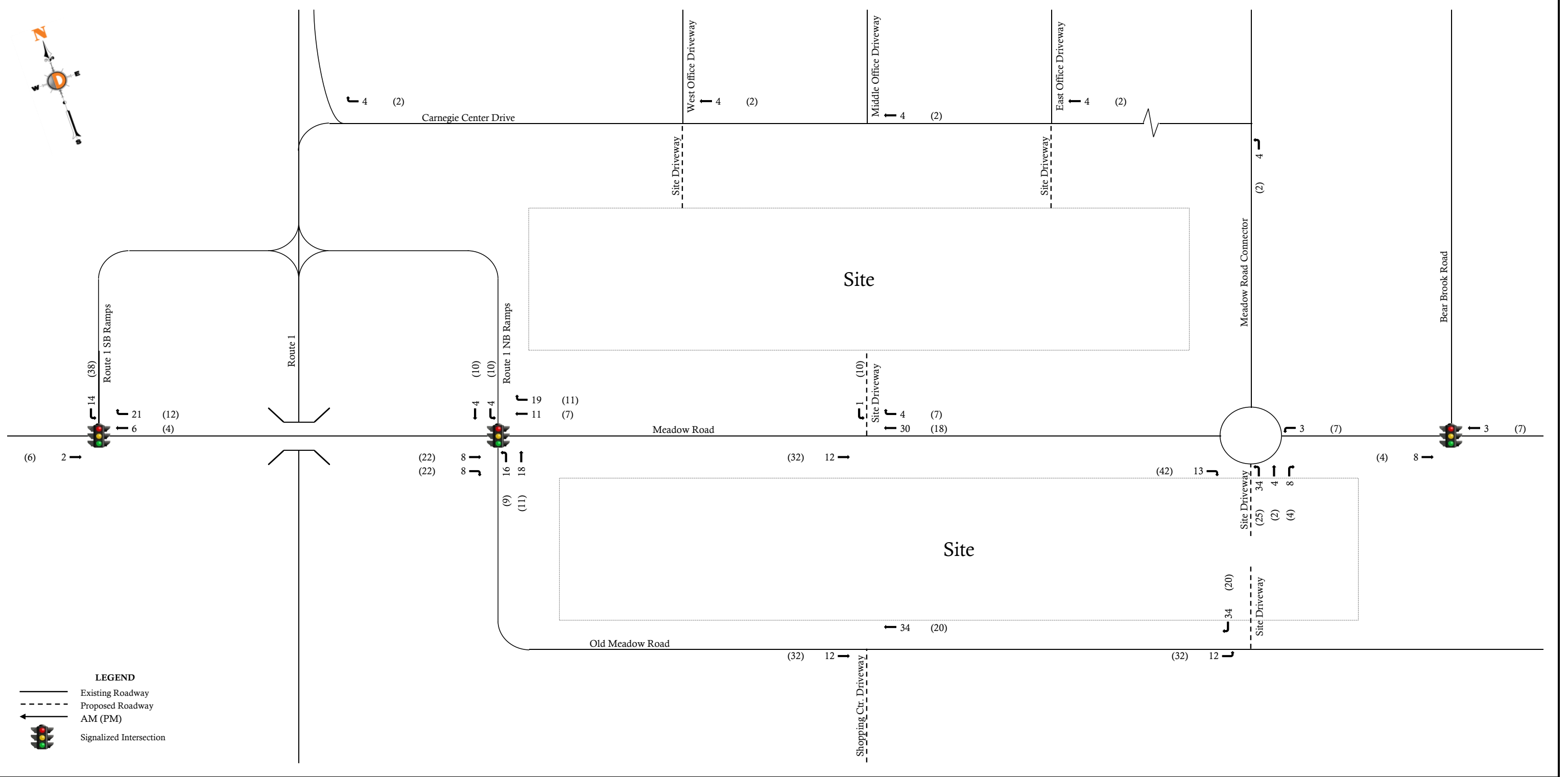

LEGEND

- Existing Roadway
- Proposed Roadway
- AM (PM)
- Signalized Intersection

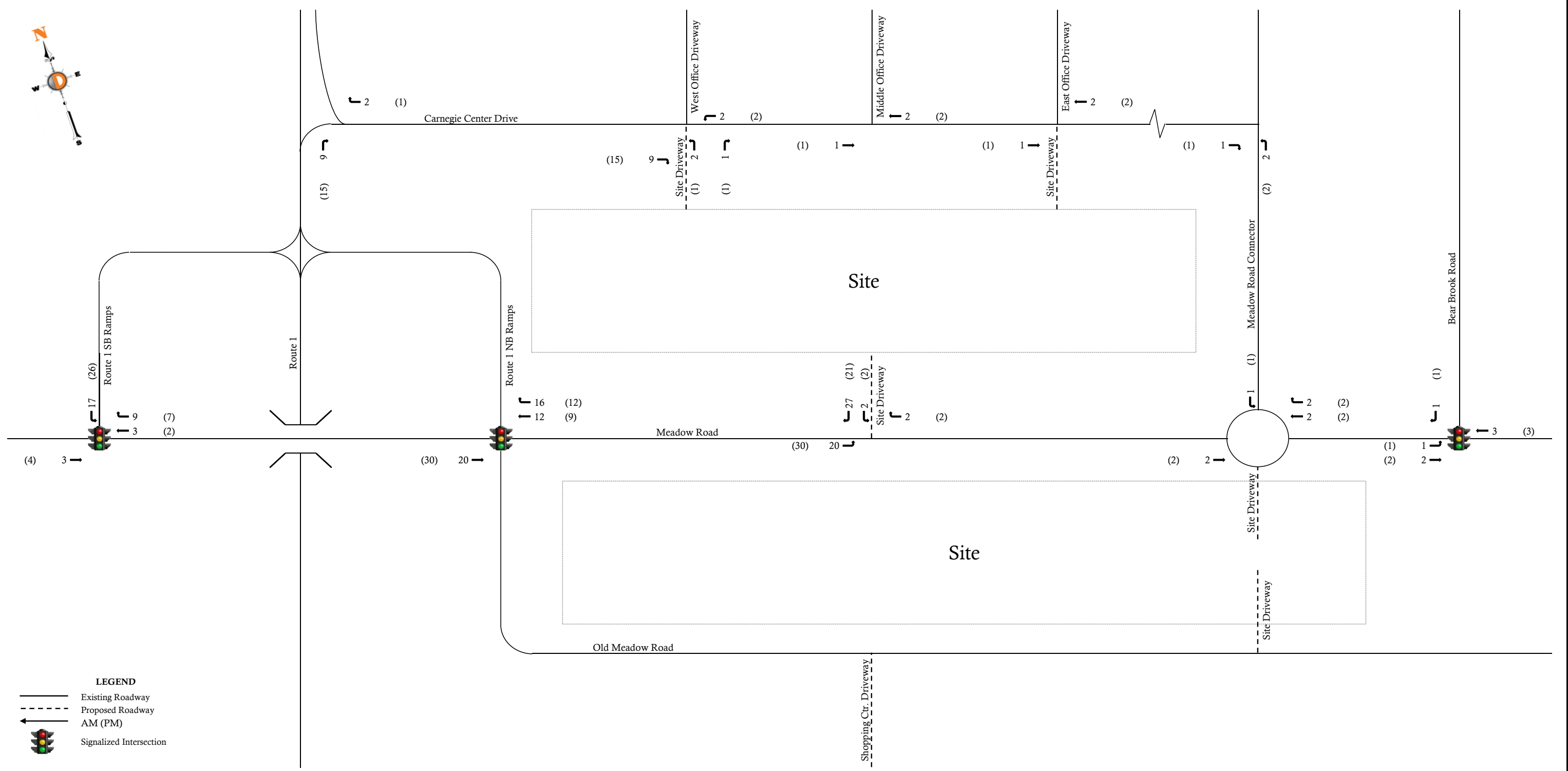

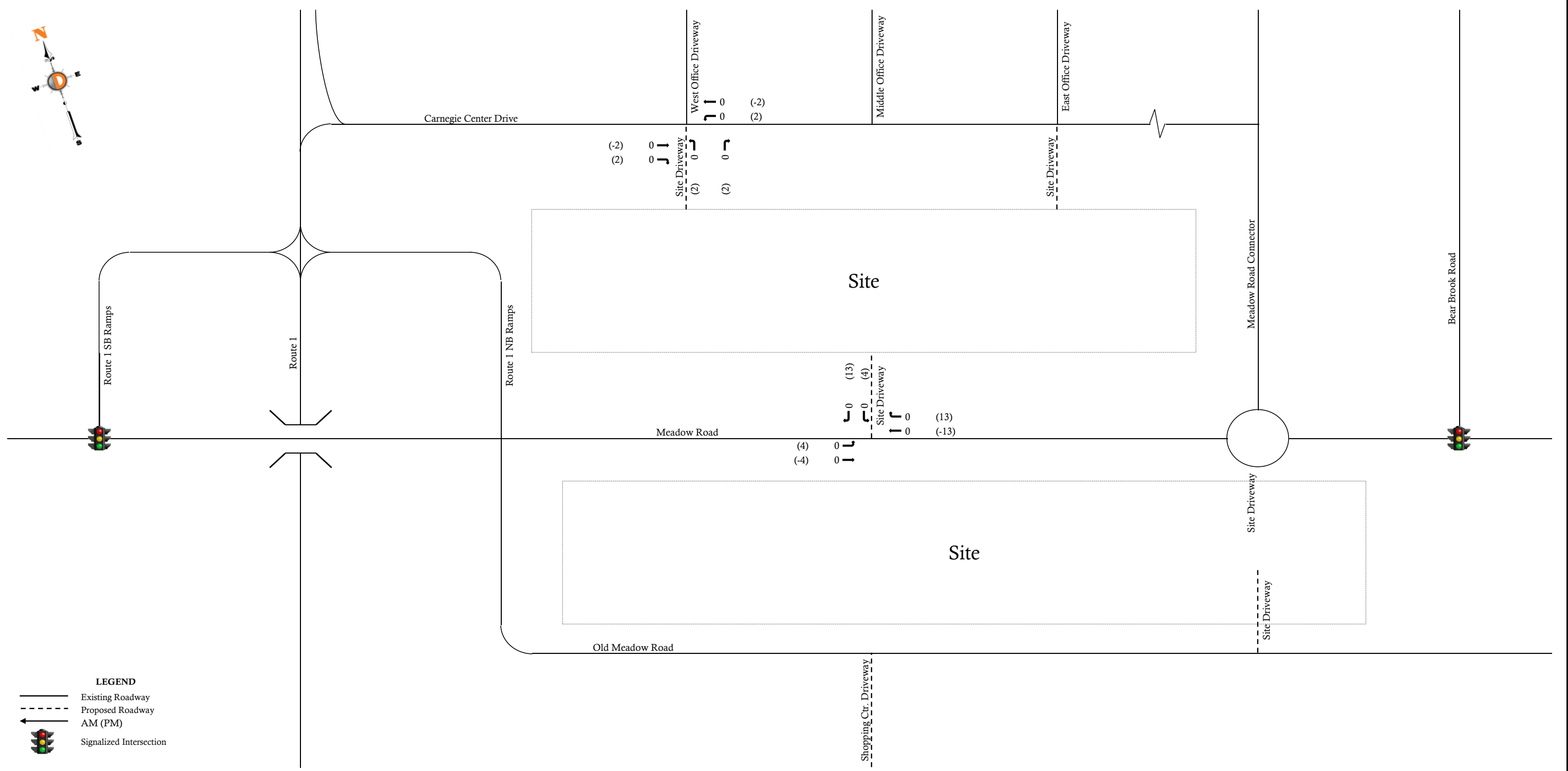

- LEGEND**
- Existing Roadway
 - - - Proposed Roadway
 - ← AM (PM)
 - 🚦 Signalized Intersection

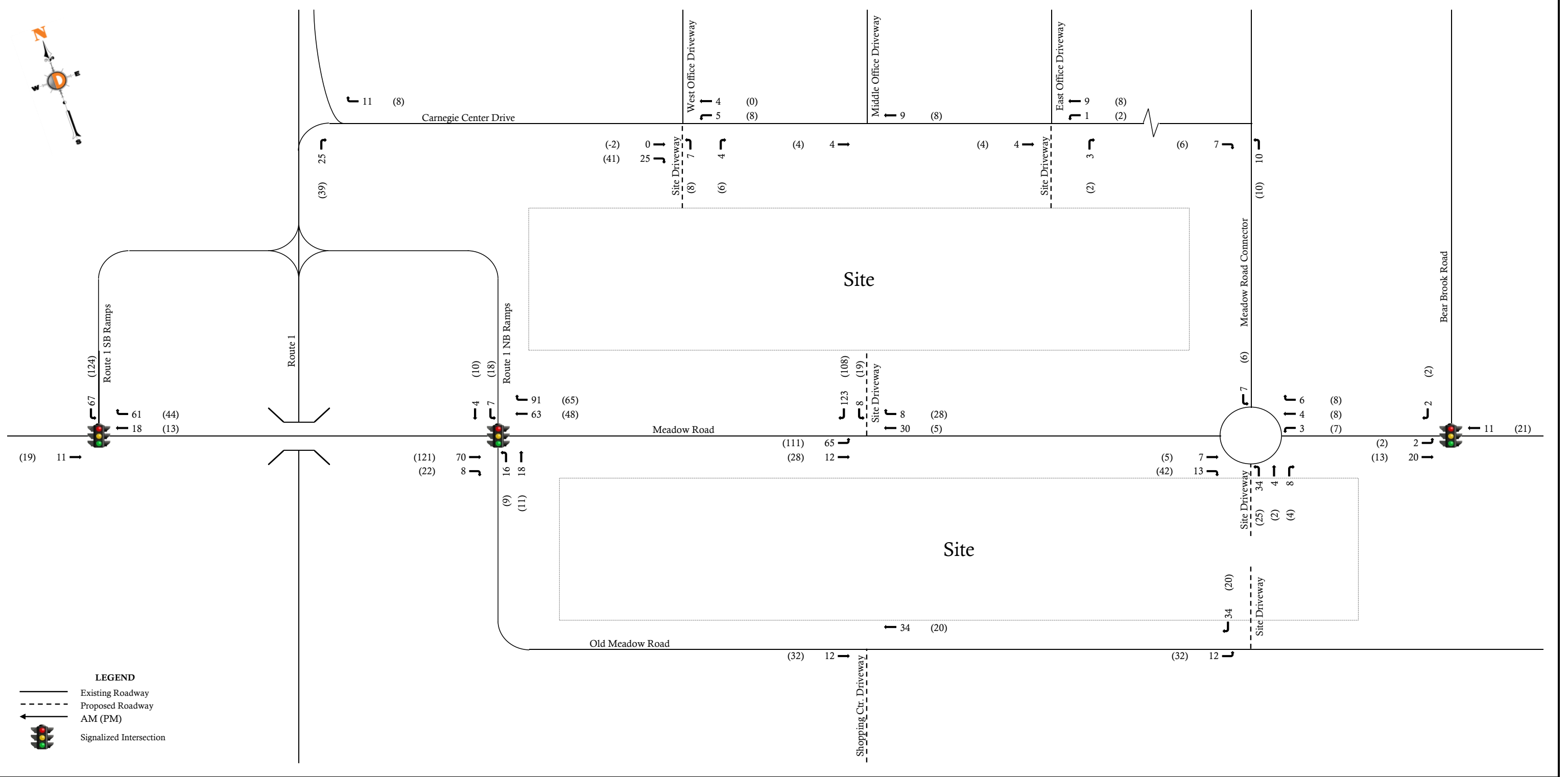

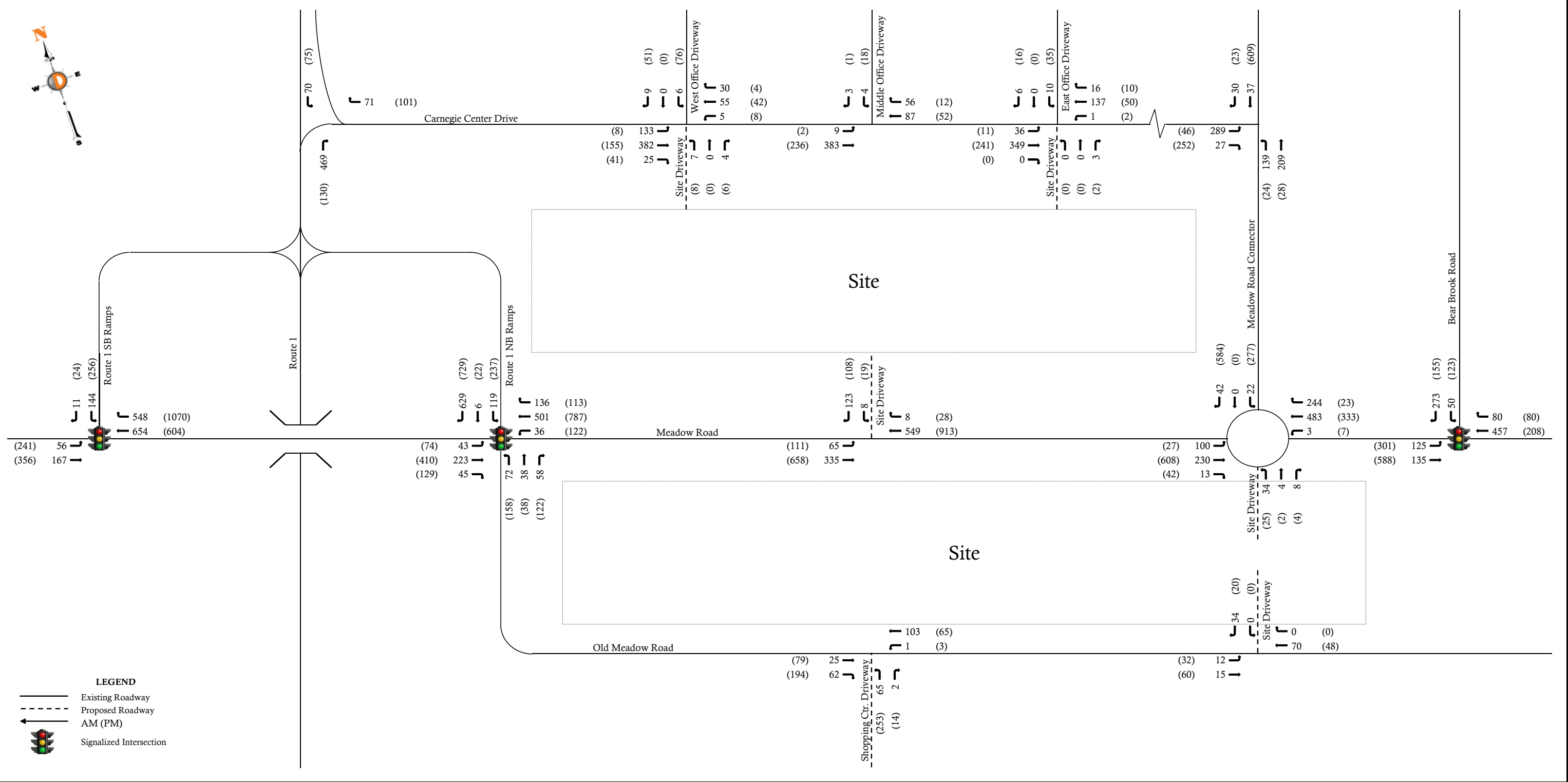

Appendix B
Traffic Counts

Dynamic Traffic, LLC

1904 Main Street, Lake Como, NJ 07719
 245 Main Street - Suite 110, Chester, NJ 07930
 732-681-0760

E/W: Meadow Road
 N/S: Rt 1 SB Ramps
 Town/County: West Windsor/Mercer
 Job #: 1096-99-002TE

File Name : Meadow Rd and Rt 1 SB Ramps - AM and PM
 Site Code : 00000000
 Start Date : 5/9/2019
 Page No : 1

Groups Printed- Cars - Trucks (SU) - Trucks (TT)

Start Time	Meadow Road Eastbound					Meadow Road Westbound					Route 1 SB Ramps Southbound					Int. Total
	Left	Thru	Right	Peds	App. Total	Left	Thru	Right	Peds	App. Total	Left	Thru	Right	Peds	App. Total	
07:00 AM	14	21	0	0	35	0	52	55	0	107	13	0	1	0	14	156
07:15 AM	10	17	0	0	27	0	63	63	0	126	11	0	1	0	12	165
07:30 AM	9	25	0	0	34	0	130	63	0	193	10	0	2	0	12	239
07:45 AM	12	33	0	0	45	0	121	85	0	206	24	0	0	0	24	275
Total	45	96	0	0	141	0	366	266	0	632	58	0	4	0	62	835
08:00 AM	16	37	0	0	53	0	153	118	0	271	23	0	1	0	24	348
08:15 AM	15	36	0	0	51	0	137	107	0	244	21	0	2	0	23	318
08:30 AM	10	47	0	0	57	0	164	113	0	277	16	0	5	0	21	355
08:45 AM	13	30	0	0	43	0	157	130	0	287	14	0	3	0	17	347
Total	54	150	0	0	204	0	611	468	0	1079	74	0	11	0	85	1368
*** BREAK ***																
04:30 PM	45	77	0	0	122	0	112	256	0	368	26	0	4	0	30	520
04:45 PM	54	56	0	0	110	0	125	279	0	404	21	0	3	0	24	538
Total	99	133	0	0	232	0	237	535	0	772	47	0	7	0	54	1058
05:00 PM	65	82	0	0	147	0	149	258	0	407	27	0	6	0	33	587
05:15 PM	57	83	0	0	140	0	155	232	0	387	38	0	7	0	45	572
05:30 PM	56	104	0	0	160	0	139	217	0	356	41	0	7	0	48	564
05:45 PM	46	57	0	0	103	0	165	224	0	389	26	0	9	0	35	527
Total	224	326	0	0	550	0	608	931	0	1539	132	0	29	0	161	2250
06:00 PM	47	83	0	0	130	0	130	199	0	329	29	0	5	0	34	493
06:15 PM	64	66	0	0	130	0	127	195	0	322	41	0	9	0	50	502
Grand Total	533	854	0	0	1387	0	2079	2594	0	4673	381	0	65	0	446	6506
Apprch %	38.4	61.6	0	0		0	44.5	55.5	0		85.4	0	14.6	0		
Total %	8.2	13.1	0	0	21.3	0	32	39.9	0	71.8	5.9	0	1	0	6.9	
Cars	522	827	0	0	1349	0	2049	2564	0	4613	378	0	65	0	443	6405
% Cars	97.9	96.8	0	0	97.3	0	98.6	98.8	0	98.7	99.2	0	100	0	99.3	98.4
Trucks (SU)	9	25	0	0	34	0	29	25	0	54	2	0	0	0	2	90
% Trucks (SU)	1.7	2.9	0	0	2.5	0	1.4	1	0	1.2	0.5	0	0	0	0.4	1.4
Trucks (TT)	2	2	0	0	4	0	1	5	0	6	1	0	0	0	1	11
% Trucks (TT)	0.4	0.2	0	0	0.3	0	0	0.2	0	0.1	0.3	0	0	0	0.2	0.2

Dynamic Traffic, LLC

1904 Main Street, Lake Como, NJ 07719
 245 Main Street - Suite 110, Chester, NJ 07930
 732-681-0760

E/W: Meadow Road File Name : Meadow Rd and Old Meadow Rd and Rt 1 NB Ramps - AM and PM
 N/S: Old Meadow Road and Rt 1 NB Ramps
 Town/County: West Windsor, NJ
 Job #: 1096-99-002TE Page No : 1

Groups Printed- Cars - Trucks (SU) - Trucks (TT)

Start Time	Meadow Road Eastbound					Meadow Road Westbound					Old Meadow Road Northbound					Route 1 NB Ramps Southbound					Int. Total
	Left	Thru	Right	Peds	App. Total	Left	Thru	Right	Peds	App. Total	Left	Thru	Right	Peds	App. Total	Left	Thru	Right	Peds	App. Total	
07:00 AM	4	23	3	0	30	3	42	12	0	57	7	5	11	0	23	15	1	61	0	77	187
07:15 AM	3	25	3	0	31	5	50	3	0	58	3	0	15	0	18	11	0	65	0	76	183
07:30 AM	2	26	5	1	34	7	60	14	0	81	9	6	11	0	26	18	1	108	0	127	268
07:45 AM	12	40	8	0	60	9	75	8	0	92	11	3	6	0	20	20	0	119	0	139	311
Total	21	114	19	1	155	24	227	37	0	288	30	14	43	0	87	64	2	353	0	419	949
08:00 AM	9	32	11	0	52	10	115	9	0	134	5	2	9	0	16	28	1	140	0	169	371
08:15 AM	10	40	7	0	57	7	92	13	0	112	14	4	20	0	38	35	0	136	0	171	378
08:30 AM	7	43	8	0	58	9	104	11	0	124	16	9	15	1	41	27	1	153	0	181	404
08:45 AM	12	26	10	0	48	9	110	10	0	129	19	4	12	1	36	17	0	158	0	175	388
Total	38	141	36	0	215	35	421	43	0	499	54	19	56	2	131	107	2	587	0	696	1541
*** BREAK ***																					
04:30 PM	12	54	27	0	93	28	183	12	0	223	32	7	32	0	71	26	2	113	0	141	528
04:45 PM	10	46	19	0	75	32	196	12	0	240	40	4	24	0	68	33	2	151	0	186	569
Total	22	100	46	0	168	60	379	24	0	463	72	11	56	0	139	59	4	264	0	327	1097
05:00 PM	26	66	21	0	113	30	196	17	0	243	36	3	25	0	64	41	3	151	0	195	615
05:15 PM	20	76	27	1	124	29	162	10	0	201	38	14	34	0	86	69	4	163	0	236	647
05:30 PM	14	90	36	0	140	26	156	7	0	189	29	5	34	0	68	67	3	162	1	233	630
05:45 PM	10	64	17	0	91	26	150	6	0	182	30	3	35	0	68	46	0	172	1	219	560
Total	70	296	101	1	468	111	664	40	0	815	133	25	128	0	286	223	10	648	2	883	2452
06:00 PM	22	65	28	0	115	27	128	8	0	163	35	6	31	0	72	41	0	146	0	187	537
06:15 PM	20	45	37	0	102	32	122	13	0	167	46	4	30	0	80	29	2	129	0	160	509
Grand Total	193	761	267	2	1223	289	1941	165	0	2395	370	79	344	2	795	523	20	2127	2	2672	7085
Apprch %	15.8	62.2	21.8	0.2		12.1	81	6.9	0		46.5	9.9	43.3	0.3		19.6	0.7	79.6	0.1		
Total %	2.7	10.7	3.8	0	17.3	4.1	27.4	2.3	0	33.8	5.2	1.1	4.9	0	11.2	7.4	0.3	30	0	37.7	
Cars	188	750	261	2	1201	285	1927											2102			
% Cars	97.4	98.6	97.8	100	98.2	98.6	99.3	99.4	0	99.2	98.9	97.5	97.4	100	98.1	98.5	100	98.8	100	98.8	98.7
Trucks (SU)																					
% Trucks (SU)	1.6	1.4	2.2	0	1.6	1.4	0.7	0.6	0	0.8	0.8	0	2.6	0	1.5	1.1	0	1	0	1	1.1
Trucks (TT)	2	0	0	0	2	0	0	0	0	0	1	2	0	0	3	2	0	4	0	6	11
% Trucks (TT)	1	0	0	0	0.2	0	0	0	0	0	0.3	2.5	0	0	0.4	0.4	0	0.2	0	0.2	0.2

Dynamic Traffic, LLC

1904 Main Street, Lake Como, NJ 07719
 245 Main Street - Suite 110, Chester, NJ 07930
 732-681-0760

E/W: Meadow Rd
 N/S: Bear Brook Rd
 Town/County: West Windsor/Mercer
 Job #: 1096-99-002TE

File Name : Meadow Rd & Bear Brook Rd - AM and PM
 Site Code : 00000000
 Start Date : 5/9/2019
 Page No : 1

Groups Printed- Cars - Trucks (SU) - Trucks (TT)

Start Time	Meadow Road Eastbound					Meadow Road Westbound					Bear Brook Road Southbound					Int. Total
	Left	Thru	Right	Peds	App. Total	Left	Thru	Right	Peds	App. Total	Left	Thru	Right	Peds	App. Total	
07:00 AM	23	18	0	0	41	0	25	11	0	36	3	0	41	0	44	121
07:15 AM	15	17	0	0	32	0	44	16	0	60	10	0	33	0	43	135
07:30 AM	24	20	0	0	44	0	56	15	0	71	6	0	42	0	48	163
07:45 AM	19	20	0	0	39	0	64	16	0	80	12	0	53	0	65	184
Total	81	75	0	0	156	0	189	58	0	247	31	0	169	0	200	603
08:00 AM	28	20	0	0	48	0	100	26	0	126	11	0	60	0	71	245
08:15 AM	34	30	0	0	64	0	105	20	0	125	17	0	60	0	77	266
08:30 AM	31	39	0	0	70	0	107	21	0	128	11	0	66	0	77	275
08:45 AM	21	18	0	0	39	0	108	10	0	118	9	0	69	0	78	235
Total	114	107	0	0	221	0	420	77	0	497	48	0	255	0	303	1021
*** BREAK ***																
04:30 PM	37	121	0	0	158	0	27	8	0	35	24	0	41	0	65	258
04:45 PM	46	114	0	0	160	0	56	18	0	74	34	0	36	0	70	304
Total	83	235	0	0	318	0	83	26	0	109	58	0	77	0	135	562
05:00 PM	60	139	0	0	199	0	48	20	0	68	29	0	39	0	68	335
05:15 PM	89	145	0	0	234	0	48	17	0	65	22	0	34	0	56	355
05:30 PM	89	148	0	0	237	0	42	22	0	64	33	0	50	0	83	384
05:45 PM	67	86	0	0	153	0	47	22	0	69	34	0	46	0	80	302
Total	305	518	0	0	823	0	185	81	0	266	118	0	169	0	287	1376
06:00 PM	72	83	0	0	155	0	53	29	0	82	41	0	38	0	79	316
06:15 PM	71	61	0	0	132	0	61	23	0	84	29	0	42	0	71	287
Grand Total	726	1079	0	0	1805	0	991	294	0	1285	325	0	750	0	1075	4165
Apprch %	40.2	59.8	0	0		0	77.1	22.9	0		30.2	0	69.8	0		
Total %	17.4	25.9	0	0	43.3	0	23.8	7.1	0	30.9	7.8	0	18	0	25.8	
Cars	713	1062	0	0	1775	0	974	282	0	1256	315	0	739	0	1054	4085
% Cars	98.2	98.4	0	0	98.3	0	98.3	95.9	0	97.7	96.9	0	98.5	0	98	98.1
Trucks (SU)	13	16	0	0	29	0	16	12	0	28	10	0	11	0	21	78
% Trucks (SU)	1.8	1.5	0	0	1.6	0	1.6	4.1	0	2.2	3.1	0	1.5	0	2	1.9
Trucks (TT)	0	1	0	0	1	0	1	0	0	1	0	0	0	0	0	2
% Trucks (TT)	0	0.1	0	0	0.1	0	0.1	0	0	0.1	0	0	0	0	0	0

Location: Rt 1 NB Off Ramp
 Cross Street: To Carnegie Center Dr
 Town/County: West Windsor/Mercer
 Job #: 1096-99-002TE

Dynamic Traffic, LLC

1904 Main Street, Lake Como, NJ 07719
 245 Main Street - Suite #110, Chester, NJ 07930
 732-681-0760

Site Code: 1602
 Station ID:

Latitude: 0' 0.0000 Undefined

Start Time	Mon 16-Sep-19	Tue 17-Sep-19	Wed 18-Sep-19	Thu 19-Sep-19	Fri 20-Sep-19	Average Day	Sat 21-Sep-19	Sun 22-Sep-19	Week Average					
12:00 AM	*	0	1	0	1	0	0	0	0					
01:00	*	0	0	0	1	0	1	0	0					
02:00	*	0	1	2	1	1	1	2	1					
03:00	*	3	6	4	5	4	3	1	4					
04:00	*	2	0	2	3	2	0	0	1					
05:00	*	17	20	16	11	16	8	0	12					
06:00	*	80	78	85	67	78	10	0	53					
07:00	*	279	269	263	239	262	63	6	186					
08:00	*	339	427	366	324	364	11	6	246					
09:00	*	197	201	184	149	183	0	6	123					
10:00	*	79	66	72	47	66	11	8	47					
11:00	*	34	43	52	49	44	13	5	33					
12:00 PM	*	73	70	63	83	72	16	6	52					
01:00	*	82	87	70	73	78	7	4	54					
02:00	*	44	42	46	37	42	8	8	31					
03:00	*	25	34	25	26	28	7	8	21					
04:00	*	29	39	40	27	34	13	6	26					
05:00	*	43	70	42	37	48	7	4	34					
06:00	*	17	23	23	14	19	7	5	15					
07:00	*	10	13	10	11	11	8	3	9					
08:00	*	5	4	7	7	6	5	4	5					
09:00	*	5	4	3	3	4	3	0	3					
10:00	*	1	1	2	6	2	1	1	2					
11:00	*	2	2	0	4	2	1	0	2					
Total	0	1366	1501	1377	1225	1366	204	83	960					
AM Peak	-	08:00	08:00	08:00	08:00	-	08:00	-	07:00	10:00	-	08:00	-	-
Vol.	-	339	427	366	324	-	364	-	63	8	-	246	-	-
PM Peak	-	13:00	13:00	13:00	12:00	-	13:00	-	12:00	14:00	-	13:00	-	-
Vol.	-	82	87	70	83	-	78	-	16	8	-	54	-	-

Location: Rt 1 NB Off Ramp
 Cross Street: To Carnegie Center Dr
 Town/County: West Windsor/Mercer
 Job #: 1096-99-002TE

Dynamic Traffic, LLC

1904 Main Street, Lake Como, NJ 07719
 245 Main Street - Suite #110, Chester, NJ 07930
 732-681-0760

Site Code: 1602
 Station ID:

Latitude: 0' 0.0000 Undefined

Start Time	Mon 23-Sep-19	Tue 24-Sep-19	Wed 25-Sep-19	Thu 26-Sep-19	Fri 27-Sep-19	Average Day	Sat 28-Sep-19	Sun 29-Sep-19	Week Average
12:00 AM	0	*	*	*	*	0	*	*	0
01:00	3	*	*	*	*	3	*	*	3
02:00	2	*	*	*	*	2	*	*	2
03:00	4	*	*	*	*	4	*	*	4
04:00	1	*	*	*	*	1	*	*	1
05:00	24	*	*	*	*	24	*	*	24
06:00	68	*	*	*	*	68	*	*	68
07:00	279	*	*	*	*	279	*	*	279
08:00	420	*	*	*	*	420	*	*	420
09:00	214	*	*	*	*	214	*	*	214
10:00	49	*	*	*	*	49	*	*	49
11:00	53	*	*	*	*	53	*	*	53
12:00 PM	57	*	*	*	*	57	*	*	57
01:00	95	*	*	*	*	95	*	*	95
02:00	36	*	*	*	*	36	*	*	36
03:00	37	*	*	*	*	37	*	*	37
04:00	32	*	*	*	*	32	*	*	32
05:00	41	*	*	*	*	41	*	*	41
06:00	17	*	*	*	*	17	*	*	17
07:00	6	*	*	*	*	6	*	*	6
08:00	8	*	*	*	*	8	*	*	8
09:00	5	*	*	*	*	5	*	*	5
10:00	1	*	*	*	*	1	*	*	1
11:00	3	*	*	*	*	3	*	*	3
Total	1455	0	0	0	0	1455	0	0	1455
AM Peak	08:00	-	-	-	-	08:00	-	-	08:00
Vol.	420	-	-	-	-	420	-	-	420
PM Peak	13:00	-	-	-	-	13:00	-	-	13:00
Vol.	95	-	-	-	-	95	-	-	95
Total	1455	1366	1501	1377	1225	2821	204	83	2415
ADT		ADT 1,030		ADT 1,030					

Dynamic Traffic, LLC

Location: Carnegie Center Dr
 Cross Street: E of Route 1
 Town/County: West Windsor/Mercer
 Job #:1096-99-002TE

1904 Main Street, Lake Como, NJ 07719
 245 Main Street - Suite #110, Chester, NJ 07930
 732-681-0760

Site Code: 1601
 Station ID:

Latitude: 0' 0.0000 Undefined

Start Time	16-Sep-19		Tue		Wed		Thu		Fri		Sat		Sun		Week Average	
	NB	SB	NB	SB	NB	SB	NB	SB	NB	SB	NB	SB	NB	SB	NB	SB
12:00 AM	*	*	0	0	1	1	0	0	1	0	1	0	2	2	1	0
01:00	*	*	0	0	1	0	0	1	0	0	0	0	0	1	0	0
02:00	*	*	4	1	2	1	2	0	2	1	2	0	1	2	2	1
03:00	*	*	1	1	1	3	0	1	1	0	0	0	0	0	0	1
04:00	*	*	0	5	0	6	0	3	0	4	0	2	0	1	0	4
05:00	*	*	2	7	1	4	5	4	2	4	0	0	0	1	2	3
06:00	*	*	5	5	9	5	6	10	7	5	1	5	1	0	5	5
07:00	*	*	28	27	22	28	26	23	27	24	4	5	1	1	18	18
08:00	*	*	58	67	52	71	48	76	39	60	7	2	3	0	34	46
09:00	*	*	54	60	31	59	32	48	22	42	2	2	0	1	24	35
10:00	*	*	28	35	24	21	25	23	16	22	7	2	5	3	18	18
11:00	*	*	30	59	29	54	31	49	25	43	3	2	4	0	20	34
12:00 PM	*	*	44	52	34	44	40	49	36	50	10	12	2	0	28	34
01:00	*	*	42	44	31	32	40	40	46	37	6	8	3	3	28	27
02:00	*	*	44	21	31	22	34	32	33	37	4	8	2	3	25	20
03:00	*	*	28	23	38	27	45	26	49	37	3	2	1	2	27	20
04:00	*	*	88	60	96	72	97	60	69	29	8	3	2	1	60	38
05:00	*	*	89	72	89	68	70	61	47	43	1	2	3	4	50	42
06:00	*	*	35	31	30	27	33	33	26	19	4	2	6	10	22	20
07:00	*	*	13	10	12	15	9	8	2	6	2	2	6	7	7	8
08:00	*	*	10	5	13	9	5	6	3	3	1	1	3	2	6	4
09:00	*	*	5	3	4	4	2	5	1	4	2	3	1	1	2	3
10:00	*	*	1	2	1	2	3	1	2	1	1	0	0	0	1	1
11:00	*	*	0	1	0	0	1	1	4	0	0	1	0	2	1	1
Total	0	0	609	591	552	575	554	560	460	471	69	64	46	47	381	383
Day	0	0	1200	1200	1127	1127	1114	1114	931	931	133	133	93	93	764	764
AM Peak	-	-	08:00	08:00	08:00	08:00	08:00	08:00	08:00	08:00	08:00	06:00	10:00	10:00	08:00	08:00
Vol.	-	-	58	67	52	71	48	76	39	60	7	5	5	3	34	46
PM Peak	-	-	17:00	17:00	16:00	16:00	16:00	17:00	16:00	12:00	12:00	12:00	18:00	18:00	16:00	17:00
Vol.	-	-	89	72	96	72	97	61	69	50	10	12	6	10	60	42

Location: Carnegie Center Dr
 Cross Street: E of Route 1
 Town/County: West Windsor/Mercer
 Job #:1096-99-002TE

Dynamic Traffic, LLC

1904 Main Street, Lake Como, NJ 07719
 245 Main Street - Suite #110, Chester, NJ 07930
 732-681-0760

Site Code: 1601
 Station ID:

Latitude: 0' 0.0000 Undefined

Start Time	23-Sep-19		Tue		Wed		Thu		Fri		Sat		Sun		Week Average	
	NB	SB	NB	SB	NB	SB	NB	SB	NB	SB	NB	SB	NB	SB	NB	SB
12:00 AM	0	1	*	*	*	*	*	*	*	*	*	*	*	*	0	1
01:00	0	1	*	*	*	*	*	*	*	*	*	*	*	*	0	1
02:00	1	1	*	*	*	*	*	*	*	*	*	*	*	*	1	1
03:00	0	0	*	*	*	*	*	*	*	*	*	*	*	*	0	0
04:00	2	5	*	*	*	*	*	*	*	*	*	*	*	*	2	5
05:00	1	6	*	*	*	*	*	*	*	*	*	*	*	*	1	6
06:00	5	3	*	*	*	*	*	*	*	*	*	*	*	*	5	3
07:00	27	39	*	*	*	*	*	*	*	*	*	*	*	*	27	39
08:00	44	66	*	*	*	*	*	*	*	*	*	*	*	*	44	66
09:00	42	56	*	*	*	*	*	*	*	*	*	*	*	*	42	56
10:00	21	20	*	*	*	*	*	*	*	*	*	*	*	*	21	20
11:00	33	42	*	*	*	*	*	*	*	*	*	*	*	*	33	42
12:00 PM	40	56	*	*	*	*	*	*	*	*	*	*	*	*	40	56
01:00	37	28	*	*	*	*	*	*	*	*	*	*	*	*	37	28
02:00	30	22	*	*	*	*	*	*	*	*	*	*	*	*	30	22
03:00	40	26	*	*	*	*	*	*	*	*	*	*	*	*	40	26
04:00	101	54	*	*	*	*	*	*	*	*	*	*	*	*	101	54
05:00	86	65	*	*	*	*	*	*	*	*	*	*	*	*	86	65
06:00	32	29	*	*	*	*	*	*	*	*	*	*	*	*	32	29
07:00	13	6	*	*	*	*	*	*	*	*	*	*	*	*	13	6
08:00	5	6	*	*	*	*	*	*	*	*	*	*	*	*	5	6
09:00	3	5	*	*	*	*	*	*	*	*	*	*	*	*	3	5
10:00	2	0	*	*	*	*	*	*	*	*	*	*	*	*	2	0
11:00	1	1	*	*	*	*	*	*	*	*	*	*	*	*	1	1
Total	566	538	0	0	0	0	0	0	0	0	0	0	0	566	538	
Day	1104		0		0		0		0		0		0		1104	
AM Peak	08:00	08:00	-	-	-	-	-	-	-	-	-	-	-	08:00	08:00	
Vol.	44	66	-	-	-	-	-	-	-	-	-	-	-	44	66	
PM Peak	16:00	17:00	-	-	-	-	-	-	-	-	-	-	-	16:00	17:00	
Vol.	101	65	-	-	-	-	-	-	-	-	-	-	-	101	65	

Comb. Total	1104	1200	1127	1114	931	133	93	1868
ADT	ADT 815	AADT 815						

Dynamic Traffic, LLC

1904 Main Street, Lake Como, NJ 07719
 245 Main Street - Suite 110, Chester, NJ 07930
 732-681-0760

E/W: Meadow Rd File Name : Meadow Rd and Meadow Rd Connector - AM and PM
 N/S: Meadow Rd Connector Site Code : 00000000
 Town/County: West Windsor/Middlesex Start Date : 5/9/2019
 Job #: 1096-99-002TE Page No : 1

Groups Printed- Cars - Trucks (SU) - Trucks (TT)

Start Time	Meadow Road Eastbound					Meadow Road Westbound					Meadow Road Connector Southbound					Int. Total
	Left	Thru	Right	Peds	App. Total	Left	Thru	Right	Peds	App. Total	Left	Thru	Right	Peds	App. Total	
07:00 AM	7	33	0	0	40	0	51	8	0	59	3	0	3	0	6	105
07:15 AM	13	37	0	0	50	0	55	19	0	74	0	0	3	0	3	127
07:30 AM	20	39	0	0	59	0	75	21	0	96	2	0	5	0	7	162
07:45 AM	20	35	0	0	55	0	75	29	0	104	0	0	7	0	7	166
Total	60	144	0	0	204	0	256	77	0	333	5	0	18	0	23	560
08:00 AM	25	42	0	0	67	0	119	45	0	164	4	0	12	0	16	247
08:15 AM	29	67	0	0	96	0	92	57	0	149	1	0	9	0	10	255
08:30 AM	27	60	0	0	87	0	106	67	0	173	2	0	7	0	9	269
08:45 AM	15	32	0	0	47	0	117	60	0	177	7	0	11	0	18	242
Total	96	201	0	0	297	0	434	229	0	663	14	0	39	0	53	1013
*** BREAK ***																
04:30 PM	4	85	0	0	89	0	68	5	0	73	49	0	123	0	172	334
04:45 PM	6	106	0	0	112	0	72	3	0	75	51	0	151	0	202	389
Total	10	191	0	0	201	0	140	8	0	148	100	0	274	0	374	723
05:00 PM	6	96	0	0	102	0	78	5	0	83	71	0	140	0	211	396
05:15 PM	8	144	0	0	152	0	74	1	0	75	69	0	130	0	199	426
05:30 PM	6	153	0	0	159	0	53	5	0	58	69	0	111	0	180	397
05:45 PM	11	102	0	0	113	0	54	2	0	56	34	0	82	0	116	285
Total	31	495	0	0	526	0	259	13	0	272	243	0	463	0	706	1504
06:00 PM	13	92	0	0	105	0	62	5	0	67	28	0	69	1	98	270
06:15 PM	4	76	0	0	80	0	67	2	0	69	26	0	65	0	91	240
Grand Total	214	1199	0	0	1413	0	1218	334	0	1552	416	0	928	1	1345	4310
Apprch %	15.1	84.9	0	0		0	78.5	21.5	0		30.9	0	69	0.1		
Total %	5	27.8	0	0	32.8	0	28.3	7.7	0	36	9.7	0	21.5	0	31.2	
Cars	214	1176	0	0	1390	0	1203	334	0	1537	416	0	925	1	1342	4269
% Cars	100	98.1	0	0	98.4	0	98.8	100	0	99	100	0	99.7	100	99.8	99
Trucks (SU)	0	20	0	0	20	0	14	0	0	14	0	0	1	0	1	35
% Trucks (SU)	0	1.7	0	0	1.4	0	1.1	0	0	0.9	0	0	0.1	0	0.1	0.8
Trucks (TT)	0	3	0	0	3	0	1	0	0	1	0	0	2	0	2	6
% Trucks (TT)	0	0.3	0	0	0.2	0	0.1	0	0	0.1	0	0	0.2	0	0.1	0.1

Dynamic Traffic, LLC

1904 Main Street, Lake Como, NJ 07719
 245 Main Street - Suite 110, Chester, NJ 07930
 732-681-0760

E/W: Carnegie Center Dr File Name : Meadow Rd Connector and Carnegie Center Dr - AM and PM
 N/S: Meadow Rd Connector Site Code : 00000000
 Town/County: West Windsor State Date : 5/9/2019
 Job #: 1096-99-002TE Page No : 1

Groups Printed- Cars - Trucks (SU) - Trucks (TT)

Start Time	Carnegie Center Drive Eastbound					Meadow Road Connector Northbound					Meadow Road Connector Southbound					Int. Total
	Left	Thru	Right	Peds	App. Total	Left	Thru	Right	Peds	App. Total	Left	Thru	Right	Peds	App. Total	
07:00 AM	28	0	4	0	32	9	14	0	0	23	0	5	1	0	6	61
07:15 AM	46	0	0	0	46	13	18	0	0	31	0	1	0	0	1	78
07:30 AM	63	0	2	0	65	13	26	0	0	39	0	6	3	0	9	113
07:45 AM	79	0	2	1	82	21	46	0	0	67	0	6	4	0	10	159
Total	216	0	8	1	225	56	104	0	0	160	0	18	8	0	26	411
08:00 AM	69	0	9	0	78	25	40	0	0	65	0	8	5	0	13	156
08:15 AM	62	0	1	0	63	29	60	0	0	89	0	5	5	0	10	162
08:30 AM	70	0	3	0	73	38	38	0	0	76	0	4	14	0	18	167
08:45 AM	77	0	6	0	83	32	46	0	0	78	0	8	5	0	13	174
Total	278	0	19	0	297	124	184	0	0	308	0	25	29	0	54	659
*** BREAK ***																
04:30 PM	15	0	65	0	80	0	6	0	0	6	0	133	2	0	135	221
04:45 PM	13	0	67	0	80	3	6	0	0	9	0	158	6	0	164	253
Total	28	0	132	0	160	3	12	0	0	15	0	291	8	0	299	474
05:00 PM	8	0	64	0	72	3	6	0	0	9	0	172	4	0	176	257
05:15 PM	11	0	60	0	71	2	7	0	0	9	0	140	5	1	146	226
05:30 PM	12	0	45	0	57	5	5	0	0	10	0	115	7	1	123	190
05:45 PM	22	0	28	0	50	3	13	0	0	16	0	92	3	0	95	161
Total	53	0	197	0	250	13	31	0	0	44	0	519	19	2	540	834
06:00 PM	11	0	18	0	29	3	10	0	0	13	0	80	1	0	81	123
06:15 PM	8	0	24	1	33	1	4	0	0	5	0	53	0	0	53	91
Grand Total	594	0	398	2	994	200	345	0	0	545	0	986	65	2	1053	2592
Apprch %	59.8	0	40	0.2		36.7	63.3	0	0		0	93.6	6.2	0.2		
Total %	22.9	0	15.4	0.1	38.3	7.7	13.3	0	0	21	0	38	2.5	0.1	40.6	
Cars	592	0	396	2	990	200	345	0	0	545	0	985	64	2	1051	2586
% Cars	99.7	0	99.5	100	99.6	100	100	0	0	100	0	99.9	98.5	100	99.8	99.8
Trucks (SU)	0	0	2	0	2	0	0	0	0	0	0	0	1	0	1	3
% Trucks (SU)	0	0	0.5	0	0.2	0	0	0	0	0	0	0	1.5	0	0.1	0.1
Trucks (TT)	2	0	0	0	2	0	0	0	0	0	0	1	0	0	1	3
% Trucks (TT)	0.3	0	0	0	0.2	0	0	0	0	0	0	0.1	0	0	0.1	0.1

Dynamic Traffic, LLC

1904 Main Street, Lake Como, NJ 07719
 245 Main Street - Suite 110, Chester, NJ 07930
 732-681-0760

E/W: Carnegie Center Dr File Name : Carnegie Center Dr and East Office Driveway - AM and PM
 N/S: East Office Driveway Site Code : 00000000
 Town/County: West Windsor/Start Date : 5/9/2019
 Job #: 1096-99-002TE Page No : 1

Groups Printed- Cars - Trucks (SU) - Trucks (TT)

Start Time	Carnegie Center Drive Eastbound					Carnegie Center Drive Westbound					East Office Driveway Southbound					Int. Total
	Left	Thru	Right	Peds	App. Total	Left	Thru	Right	Peds	App. Total	Left	Thru	Right	Peds	App. Total	
07:00 AM	4	0	0	0	4	0	0	0	0	0	1	0	1	0	2	6
07:15 AM	1	0	0	0	1	0	0	1	0	1	0	0	1	0	1	3
07:30 AM	1	0	0	0	1	0	0	3	0	3	0	0	0	0	0	4
07:45 AM	5	0	0	0	5	0	0	2	0	2	1	0	0	0	1	8
Total	11	0	0	0	11	0	0	6	0	6	2	0	2	0	4	21
08:00 AM	2	0	0	0	2	0	0	2	0	2	7	0	1	0	8	12
08:15 AM	7	0	0	0	7	0	0	6	0	6	1	0	1	0	2	15
08:30 AM	12	0	0	0	12	0	0	4	0	4	0	0	1	0	1	17
08:45 AM	14	0	0	0	14	0	0	3	0	3	2	0	3	0	5	22
Total	35	0	0	0	35	0	0	15	0	15	10	0	6	0	16	66
*** BREAK ***																
04:30 PM	2	0	0	0	2	0	0	1	0	1	6	0	1	0	7	10
04:45 PM	0	0	0	0	0	0	0	1	0	1	7	0	3	0	10	11
Total	2	0	0	0	2	0	0	2	0	2	13	0	4	0	17	21
05:00 PM	1	0	0	0	1	0	0	1	0	1	8	0	5	0	13	15
05:15 PM	4	0	0	0	4	0	0	4	0	4	12	0	5	0	17	25
05:30 PM	6	0	0	0	6	0	0	4	0	4	7	0	2	0	9	19
05:45 PM	3	0	0	0	3	0	0	3	0	3	8	0	1	0	9	15
Total	14	0	0	0	14	0	0	12	0	12	35	0	13	0	48	74
06:00 PM	4	0	0	0	4	0	0	0	0	0	4	0	3	0	7	11
06:15 PM	3	0	0	0	3	0	0	0	0	0	1	0	0	0	1	4
Grand Total	69	0	0	0	69	0	0	35	0	35	65	0	28	0	93	197
Apprch %	100	0	0	0		0	0	100	0		69.9	0	30.1	0		
Total %	35	0	0	0	35	0	0	17.8	0	17.8	33	0	14.2	0	47.2	
Cars	66	0	0	0	66	0	0	34	0	34	63	0	28	0	91	191
% Cars	95.7	0	0	0	95.7	0	0	97.1	0	97.1	96.9	0	100	0	97.8	97
Trucks (SU)	3	0	0	0	3	0	0	1	0	1	2	0	0	0	2	6
% Trucks (SU)	4.3	0	0	0	4.3	0	0	2.9	0	2.9	3.1	0	0	0	2.2	3
Trucks (TT)	0	0	0	0	0	0	0	0	0	0	0	0	0	0	0	0
% Trucks (TT)	0	0	0	0	0	0	0	0	0	0	0	0	0	0	0	0

Dynamic Traffic, LLC

1904 Main Street, Lake Como, NJ 07719
 245 Main Street - Suite 110, Chester, NJ 07930
 732-681-0760

E/W: Shopping Ctr. Driveway File Name : Old Meadow Rd and Shopping Ctr. Driveway - AM and PM
 N/S: Old Meadow Road Site Code : 00000000
 Town/County: West Winsor/Morristown Start Date : 5/9/2019
 Job #: 1096-99-002TE Page No : 1

Groups Printed- Cars - Trucks (SU) - Trucks (TT)

Start Time	Shopping Ctr. Driveway Eastbound					Old Meadow Road Northbound					Old Meadow Road Southbound					Int. Total
	Left	Thru	Right	Peds	App. Total	Left	Thru	Right	Peds	App. Total	Left	Thru	Right	Peds	App. Total	
07:00 AM	6	0	1	0	7	0	14	0	0	14	0	4	4	1	9	30
07:15 AM	3	0	1	0	4	0	11	0	0	11	0	2	6	4	12	27
07:30 AM	12	0	0	0	12	0	20	0	0	20	0	6	6	1	13	45
07:45 AM	9	0	0	0	9	1	10	0	0	11	0	6	12	0	18	38
Total	30	0	2	0	32	1	55	0	0	56	0	18	28	6	52	140
08:00 AM	10	0	0	0	10	1	8	0	0	9	0	4	19	0	23	42
08:15 AM	16	0	1	0	17	0	17	0	0	17	0	1	12	3	16	50
08:30 AM	16	0	1	0	17	0	24	0	0	24	0	4	16	0	20	61
08:45 AM	17	0	0	0	17	0	15	0	0	15	0	3	13	0	16	48
Total	59	0	2	0	61	1	64	0	0	65	0	12	60	3	75	201
*** BREAK ***																
04:30 PM	55	0	6	0	61	3	8	0	0	11	0	10	39	0	49	121
04:45 PM	50	0	2	0	52	0	10	0	0	10	0	6	42	0	48	110
Total	105	0	8	0	113	3	18	0	0	21	0	16	81	0	97	231
05:00 PM	59	0	4	0	63	2	10	0	0	12	0	7	51	0	58	133
05:15 PM	68	0	3	0	71	1	11	0	0	12	0	15	40	0	55	138
05:30 PM	56	0	4	0	60	0	8	0	0	8	0	17	54	0	71	139
05:45 PM	63	0	0	0	63	1	6	0	0	7	0	8	30	0	38	108
Total	246	0	11	0	257	4	35	0	0	39	0	47	175	0	222	518
06:00 PM	60	0	2	0	62	1	14	0	0	15	0	7	54	0	61	138
06:15 PM	64	0	6	0	70	1	11	0	0	12	0	14	51	0	65	147
Grand Total	564	0	31	0	595	11	197	0	0	208	0	114	449	9	572	1375
Apprch %	94.8	0	5.2	0		5.3	94.7	0	0		0	19.9	78.5	1.6		
Total %	41	0	2.3	0	43.3	0.8	14.3	0	0	15.1	0	8.3	32.7	0.7	41.6	
Cars	564	0	31	0	595	10	188	0	0	198	0	107	446	9	562	1355
% Cars	100	0	100	0	100	90.9	95.4	0	0	95.2	0	93.9	99.3	100	98.3	98.5
Trucks (SU)	0	0	0	0	0	1	7	0	0	8	0	7	3	0	10	18
% Trucks (SU)	0	0	0	0	0	9.1	3.6	0	0	3.8	0	6.1	0.7	0	1.7	1.3
Trucks (TT)	0	0	0	0	0	0	2	0	0	2	0	0	0	0	0	2
% Trucks (TT)	0	0	0	0	0	0	1	0	0	1	0	0	0	0	0	0.1

Appendix C
Capacity Analysis



Lane Group	EBL	EBT	WBT	WBR	SBL	SBR
Lane Configurations						
Traffic Volume (vph)	54	150	611	468	74	11
Future Volume (vph)	54	150	611	468	74	11
Ideal Flow (vphpl)	1900	1900	1900	1900	1900	1900
Grade (%)		0%	-1%		0%	
Storage Length (ft)	220			0	125	125
Storage Lanes	1			1	2	0
Taper Length (ft)	25				25	
Satd. Flow (prot)	1656	1792	3592	1576	3367	1553
Flt Permitted	0.389				0.950	
Satd. Flow (perm)	678	1792	3592	1576	3367	1553
Right Turn on Red				Yes		Yes
Satd. Flow (RTOR)				488		11
Link Speed (mph)		25	25		25	
Link Distance (ft)		608	1114		279	
Travel Time (s)		16.6	30.4		7.6	
Peak Hour Factor	0.96	0.96	0.96	0.96	0.96	0.96
Heavy Vehicles (%)	9%	6%	1%	3%	4%	4%
Shared Lane Traffic (%)						
Lane Group Flow (vph)	56	156	636	488	77	11
Turn Type	pm+pt	NA	NA	Free	Perm	Perm
Protected Phases	5	2	6			
Permitted Phases	2			Free	4	4
Total Split (s)	15.0	66.0	51.0		34.0	34.0
Total Lost Time (s)	3.0	6.0	6.0		6.0	6.0
Act Effct Green (s)	66.0	64.2	58.4	81.8	10.0	10.0
Actuated g/C Ratio	0.81	0.78	0.71	1.00	0.12	0.12
v/c Ratio	0.09	0.11	0.25	0.31	0.19	0.06
Control Delay	2.6	3.3	6.2	0.5	33.7	18.1
Queue Delay	0.0	0.0	0.0	0.0	0.0	0.0
Total Delay	2.6	3.3	6.2	0.5	33.7	18.1
LOS	A	A	A	A	C	B
Approach Delay		3.1	3.8		31.7	
Approach LOS		A	A		C	
Queue Length 50th (ft)	5	19	71	0	18	0
Queue Length 95th (ft)	12	34	101	0	38	15
Internal Link Dist (ft)		528	1034		199	
Turn Bay Length (ft)	220				125	125
Base Capacity (vph)	691	1407	2564	1576	1152	538
Starvation Cap Reductn	0	0	0	0	0	0
Spillback Cap Reductn	0	0	0	0	0	0
Storage Cap Reductn	0	0	0	0	0	0
Reduced v/c Ratio	0.08	0.11	0.25	0.31	0.07	0.02

Intersection Summary

Area Type: Other
 Cycle Length: 100
 Actuated Cycle Length: 81.8
 Control Type: Semi Act-Uncoord

Maximum v/c Ratio: 0.31

Intersection Signal Delay: 5.4

Intersection LOS: A

Intersection Capacity Utilization 63.2%

ICU Level of Service B

Analysis Period (min) 15

Splits and Phases: 10: Meadow Road & Route 1 SB Ramps



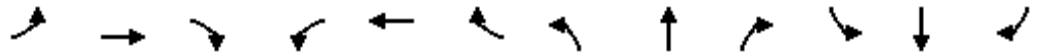

Lane Group	EBL	EBT	EBR	WBL	WBT	WBR	NBL	NBT	NBR	SBL	SBT	SBR
Lane Configurations												
Traffic Volume (vph)	41	147	36	35	421	43	54	19	56	107	2	604
Future Volume (vph)	41	147	36	35	421	43	54	19	56	107	2	604
Ideal Flow (vphpl)	1900	1900	1900	1900	1900	1900	1900	1900	1900	1900	1900	1900
Lane Width (ft)	12	12	12	12	12	12	12	11	11	13	13	16
Grade (%)		-5%			3%			3%			2%	
Storage Length (ft)	115		0	325		450	0		0	120		0
Storage Lanes	1		0	1		1	1		0	1		1
Taper Length (ft)	25			25			25			25		
Satd. Flow (prot)	1814	3438	0	1726	3521	1560	1710	1530	0	1775	1944	1794
Flt Permitted	0.487			0.630			0.500			0.800		
Satd. Flow (perm)	930	3438	0	1145	3521	1560	900	1530	0	1495	1944	1794
Right Turn on Red			Yes			Yes			Yes			Yes
Satd. Flow (RTOR)		29				87		59				610
Link Speed (mph)		25			25			25				25
Link Distance (ft)		1114			551			434				429
Travel Time (s)		30.4			15.0			11.8				11.7
Peak Hour Factor	0.95	0.95	0.95	0.95	0.95	0.95	0.95	0.95	0.95	0.95	0.95	0.95
Heavy Vehicles (%)	2%	4%	6%	3%	1%	2%	4%	5%	5%	4%	0%	1%
Shared Lane Traffic (%)												
Lane Group Flow (vph)	43	193	0	37	443	45	57	79	0	113	2	636
Turn Type	pm+pt	NA		pm+pt	NA	Perm	pm+pt	NA		pm+pt	NA	Free
Protected Phases	5	2		1	6		3	8		7	4	
Permitted Phases	2			6		6	8			4		Free
Total Split (s)	15.0	59.0		15.0	59.0	59.0	16.0	36.0		16.0	36.0	
Total Lost Time (s)	3.0	6.0		3.0	6.0	6.0	3.0	7.0		3.0	7.0	
Act Effct Green (s)	60.8	53.8		60.7	53.8	53.8	23.0	10.4		15.9	10.8	94.4
Actuated g/C Ratio	0.64	0.57		0.64	0.57	0.57	0.24	0.11		0.17	0.11	1.00
v/c Ratio	0.07	0.10		0.05	0.22	0.05	0.15	0.36		0.39	0.01	0.35
Control Delay	6.9	9.8		6.8	12.1	0.6	27.1	22.0		39.9	40.5	0.5
Queue Delay	0.0	0.0		0.0	0.0	0.0	0.0	0.0		0.0	0.0	0.0
Total Delay	6.9	9.8		6.8	12.1	0.6	27.1	22.0		39.9	40.5	0.5
LOS	A	A		A	B	A	C	C		D	D	A
Approach Delay		9.3			10.7			24.2			6.6	
Approach LOS		A			B			C			A	
Queue Length 50th (ft)	9	26		8	77	0	27	12		69	1	0
Queue Length 95th (ft)	22	47		20	114	4	58	58		101	8	0
Internal Link Dist (ft)		1034			471			354			349	
Turn Bay Length (ft)	115			325		450				120		
Base Capacity (vph)	728	1972		831	2005	925	431	517		303	605	1794
Starvation Cap Reductn	0	0		0	0	0	0	0		0	0	0
Spillback Cap Reductn	0	0		0	0	0	0	0		0	0	0
Storage Cap Reductn	0	0		0	0	0	0	0		0	0	0
Reduced v/c Ratio	0.06	0.10		0.04	0.22	0.05	0.13	0.15		0.37	0.00	0.35

Intersection Summary

Area Type: Other
 Cycle Length: 126
 Actuated Cycle Length: 94.4

Control Type: Semi Act-Uncoord

Maximum v/c Ratio: 0.39

Intersection Signal Delay: 9.7









Intersection LOS: A

Intersection Capacity Utilization 70.8%

ICU Level of Service C

Analysis Period (min) 15

Splits and Phases: 20: Old Meadow Rd/Route 1 NB Ramps & Meadow Road

 Ø1	 Ø2	 Ø3	 Ø4
15 s	59 s	16 s	36 s
 Ø5	 Ø6	 Ø7	 Ø8
15 s	59 s	16 s	36 s

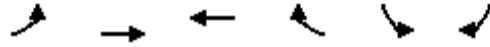

Lane Group	EBL	EBT	WBT	WBR	SBL	SBR
Lane Configurations						
Traffic Volume (vph)	118	110	428	77	48	260
Future Volume (vph)	118	110	428	77	48	260
Ideal Flow (vphpl)	1900	1900	1900	1900	1900	1900
Lane Width (ft)	12	12	11	13	11	11
Grade (%)		1%	0%		0%	
Storage Length (ft)	190			155	265	0
Storage Lanes	1			1	1	1
Taper Length (ft)	25				25	
Satd. Flow (prot)	1727	1750	1818	1560	1517	1531
Flt Permitted	0.484				0.950	
Satd. Flow (perm)	880	1750	1818	1560	1517	1531
Right Turn on Red				Yes		Yes
Satd. Flow (RTOR)						280
Link Speed (mph)		25	25		25	
Link Distance (ft)		2245	457		697	
Travel Time (s)		61.2	12.5		19.0	
Peak Hour Factor	0.93	0.93	0.93	0.93	0.93	0.93
Heavy Vehicles (%)	4%	8%	1%	7%	15%	2%
Shared Lane Traffic (%)						
Lane Group Flow (vph)	127	118	460	83	52	280
Turn Type	Perm	NA	NA	pm+ov	Prot	Prot
Protected Phases		2	6	4	4	8
Permitted Phases	2			6		
Total Split (s)	55.0	55.0	55.0	35.0	35.0	35.0
Total Lost Time (s)	5.0	5.0	5.0	5.0	5.0	5.0
Act Effct Green (s)	50.1	50.1	50.1	68.9	8.8	8.8
Actuated g/C Ratio	0.73	0.73	0.73	1.00	0.13	0.13
v/c Ratio	0.20	0.09	0.35	0.05	0.27	0.64
Control Delay	4.3	3.4	4.6	0.1	30.4	11.1
Queue Delay	0.0	0.0	0.0	0.0	0.0	0.0
Total Delay	4.3	3.4	4.6	0.1	30.4	11.1
LOS	A	A	A	A	C	B
Approach Delay		3.9	3.9		14.2	
Approach LOS		A	A		B	
Queue Length 50th (ft)	12	11	51	0	20	0
Queue Length 95th (ft)	38	30	118	0	50	61
Internal Link Dist (ft)		2165	377		617	
Turn Bay Length (ft)	190			155	265	
Base Capacity (vph)	639	1271	1321	1560	661	825
Starvation Cap Reductn	0	0	0	0	0	0
Spillback Cap Reductn	0	0	0	0	0	0
Storage Cap Reductn	0	0	0	0	0	0
Reduced v/c Ratio	0.20	0.09	0.35	0.05	0.08	0.34

Intersection Summary

Area Type: Other

Cycle Length: 90

Actuated Cycle Length: 68.9

Control Type: Semi Act-Uncoord

Maximum v/c Ratio: 0.64

Intersection Signal Delay: 6.9

Intersection LOS: A

Intersection Capacity Utilization 101.7%

ICU Level of Service G

Analysis Period (min) 15

Splits and Phases: 40: Meadow Road & Bear Brook Road

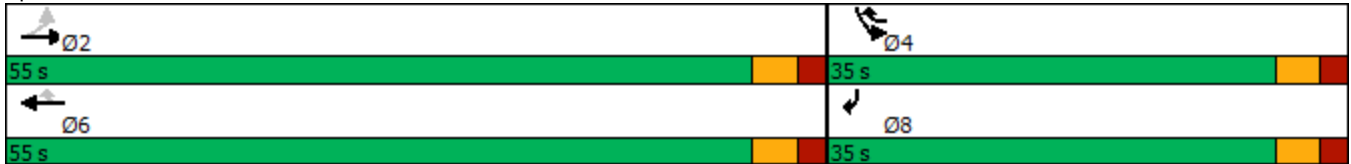

Intersection						
Int Delay, s/veh	9.3					
Movement	EBT	EBR	WBL	WBT	NBL	NBR
Lane Configurations	↑			↑		↑
Traffic Vol, veh/h	67	0	0	58	0	427
Future Vol, veh/h	67	0	0	58	0	427
Conflicting Peds, #/hr	0	0	0	0	0	0
Sign Control	Free	Free	Free	Free	Stop	Stop
RT Channelized	-	None	-	None	-	Yield
Storage Length	-	-	-	-	-	0
Veh in Median Storage, #	0	-	-	0	0	-
Grade, %	0	-	-	0	0	-
Peak Hour Factor	90	90	90	90	90	90
Heavy Vehicles, %	2	2	2	2	2	2
Mvmt Flow	74	0	0	64	0	474

Major/Minor	Major1	Major2	Minor1	Minor2
Conflicting Flow All	0	-	-	74
Stage 1	-	-	-	-
Stage 2	-	-	-	-
Critical Hdwy	-	-	-	6.22
Critical Hdwy Stg 1	-	-	-	-
Critical Hdwy Stg 2	-	-	-	-
Follow-up Hdwy	-	-	-	3.318
Pot Cap-1 Maneuver	-	0	0	988
Stage 1	-	0	0	-
Stage 2	-	0	0	-
Platoon blocked, %	-	-	-	-
Mov Cap-1 Maneuver	-	-	-	988
Mov Cap-2 Maneuver	-	-	-	-
Stage 1	-	-	-	-
Stage 2	-	-	-	-

Approach	EB	WB	NB
HCM Control Delay, s	0	0	12
HCM LOS			B

Minor Lane/Major Mvmt	NBLn1	EBT	WBT
Capacity (veh/h)	988	-	-
HCM Lane V/C Ratio	0.48	-	-
HCM Control Delay (s)	12	-	-
HCM Lane LOS	B	-	-
HCM 95th %tile Q(veh)	2.7	-	-

Intersection

Int Delay, s/veh 1.6

Movement	EBL	EBT	WBT	WBR	SBL	SBR
Lane Configurations	↘	↗	↗	↘	↘	↘
Traffic Vol, veh/h	96	214	459	229	14	40
Future Vol, veh/h	96	214	459	229	14	40
Conflicting Peds, #/hr	0	0	0	0	0	0
Sign Control	Free	Free	Free	Free	Stop	Stop
RT Channelized	-	None	-	None	-	None
Storage Length	250	-	-	135	0	0
Veh in Median Storage, #	-	0	0	-	0	-
Grade, %	-	0	2	-	-1	-
Peak Hour Factor	94	94	94	94	94	94
Heavy Vehicles, %	0	6	1	0	0	0
Mvmt Flow	102	228	488	244	15	43

Major/Minor	Major1	Major2	Minor2
Conflicting Flow All	732	0	0
Stage 1	-	-	488
Stage 2	-	-	432
Critical Hdwy	4.1	-	6.2
Critical Hdwy Stg 1	-	-	5.2
Critical Hdwy Stg 2	-	-	5.2
Follow-up Hdwy	2.2	-	3.5
Pot Cap-1 Maneuver	882	-	319
Stage 1	-	-	638
Stage 2	-	-	675
Platoon blocked, %	-	-	-
Mov Cap-1 Maneuver	882	-	282
Mov Cap-2 Maneuver	-	-	282
Stage 1	-	-	564
Stage 2	-	-	675

Approach	EB	WB	SB
HCM Control Delay, s	3	0	13.4
HCM LOS			B

Minor Lane/Major Mvmt	EBL	EBT	WBT	WBR	SBLn1	SBLn2
Capacity (veh/h)	882	-	-	-	282	592
HCM Lane V/C Ratio	0.116	-	-	-	0.053	0.072
HCM Control Delay (s)	9.6	-	-	-	18.5	11.6
HCM Lane LOS	A	-	-	-	C	B
HCM 95th %tile Q(veh)	0.4	-	-	-	0.2	0.2

Intersection						
Int Delay, s/veh	12.6					
Movement	EBL	EBR	NBL	NBT	SBT	SBR
Lane Configurations	↙	↗	↙	↑	↗	
Traffic Vol, veh/h	278	19	124	201	35	29
Future Vol, veh/h	278	19	124	201	35	29
Conflicting Peds, #/hr	0	0	0	0	0	0
Sign Control	Stop	Stop	Free	Free	Free	Free
RT Channelized	-	None	-	None	-	None
Storage Length	100	0	0	-	-	-
Veh in Median Storage, #	0	-	-	0	0	-
Grade, %	1	-	-	-2	1	-
Peak Hour Factor	93	93	93	93	93	93
Heavy Vehicles, %	0	0	0	0	0	0
Mvmt Flow	299	20	133	216	38	31

Major/Minor	Minor2	Major1		Major2	
Conflicting Flow All	536	54	69	0	0
Stage 1	54	-	-	-	-
Stage 2	482	-	-	-	-
Critical Hdwy	6.6	6.3	4.1	-	-
Critical Hdwy Stg 1	5.6	-	-	-	-
Critical Hdwy Stg 2	5.6	-	-	-	-
Follow-up Hdwy	3.5	3.3	2.2	-	-
Pot Cap-1 Maneuver	494	1017	1545	-	-
Stage 1	971	-	-	-	-
Stage 2	609	-	-	-	-
Platoon blocked, %				-	-
Mov Cap-1 Maneuver	452	1017	1545	-	-
Mov Cap-2 Maneuver	452	-	-	-	-
Stage 1	887	-	-	-	-
Stage 2	609	-	-	-	-

Approach	EB	NB	SB
HCM Control Delay, s	26	2.9	0
HCM LOS	D		

Minor Lane/Major Mvmt	NBL	NBT	EBLn1	EBLn2	SBT	SBR
Capacity (veh/h)	1545	-	452	1017	-	-
HCM Lane V/C Ratio	0.086	-	0.661	0.02	-	-
HCM Control Delay (s)	7.5	-	27.2	8.6	-	-
HCM Lane LOS	A	-	D	A	-	-
HCM 95th %tile Q(veh)	0.3	-	4.7	0.1	-	-

Intersection

Int Delay, s/veh 0.8

Movement	EBL	EBT	WBT	WBR	SBL	SBR
Lane Configurations	↙	↑	↘		↙	
Traffic Vol, veh/h	35	332	123	15	10	6
Future Vol, veh/h	35	332	123	15	10	6
Conflicting Peds, #/hr	0	0	0	0	0	0
Sign Control	Free	Free	Free	Free	Stop	Stop
RT Channelized	-	None	-	None	-	None
Storage Length	125	-	-	-	0	-
Veh in Median Storage, #	-	0	0	-	0	-
Grade, %	-	-1	1	-	0	-
Peak Hour Factor	90	90	90	90	90	90
Heavy Vehicles, %	3	0	0	0	0	0
Mvmt Flow	39	369	137	17	11	7

Major/Minor	Major1	Major2	Minor2		
Conflicting Flow All	154	0	-	0	593 146
Stage 1	-	-	-	-	146 -
Stage 2	-	-	-	-	447 -
Critical Hdwy	4.13	-	-	-	6.4 6.2
Critical Hdwy Stg 1	-	-	-	-	5.4 -
Critical Hdwy Stg 2	-	-	-	-	5.4 -
Follow-up Hdwy	2.227	-	-	-	3.5 3.3
Pot Cap-1 Maneuver	1420	-	-	-	472 906
Stage 1	-	-	-	-	886 -
Stage 2	-	-	-	-	649 -
Platoon blocked, %		-	-	-	
Mov Cap-1 Maneuver	1420	-	-	-	459 906
Mov Cap-2 Maneuver	-	-	-	-	459 -
Stage 1	-	-	-	-	862 -
Stage 2	-	-	-	-	649 -

Approach	EB	WB	SB
HCM Control Delay, s	0.7	0	11.6
HCM LOS			B

Minor Lane/Major Mvmt	EBL	EBT	WBT	WBR	SBLn1
Capacity (veh/h)	1420	-	-	-	563
HCM Lane V/C Ratio	0.027	-	-	-	0.032
HCM Control Delay (s)	7.6	-	-	-	11.6
HCM Lane LOS	A	-	-	-	B
HCM 95th %tile Q(veh)	0.1	-	-	-	0.1

Intersection

Int Delay, s/veh 0.3

Movement	EBL	EBT	WBT	WBR	SBL	SBR
Lane Configurations						
Traffic Vol, veh/h	9	363	75	54	4	3
Future Vol, veh/h	9	363	75	54	4	3
Conflicting Peds, #/hr	0	0	0	0	0	0
Sign Control	Free	Free	Free	Free	Stop	Stop
RT Channelized	-	None	-	None	-	None
Storage Length	125	-	-	-	0	-
Veh in Median Storage, #	-	0	0	-	0	-
Grade, %	-	-1	1	-	0	-
Peak Hour Factor	90	90	90	90	90	90
Heavy Vehicles, %	0	0	0	0	0	0
Mvmt Flow	10	403	83	60	4	3

Major/Minor	Major1	Major2	Minor2
Conflicting Flow All	143	0	0
Stage 1	-	-	-
Stage 2	-	-	-
Critical Hdwy	4.1	-	-
Critical Hdwy Stg 1	-	-	-
Critical Hdwy Stg 2	-	-	-
Follow-up Hdwy	2.2	-	-
Pot Cap-1 Maneuver	1452	-	-
Stage 1	-	-	-
Stage 2	-	-	-
Platoon blocked, %	-	-	-
Mov Cap-1 Maneuver	1452	-	-
Mov Cap-2 Maneuver	-	-	-
Stage 1	-	-	-
Stage 2	-	-	-

Approach	EB	WB	SB
HCM Control Delay, s	0.2	0	10.8
HCM LOS			B

Minor Lane/Major Mvmt	EBL	EBT	WBT	WBR	SBLn1
Capacity (veh/h)	1452	-	-	-	631
HCM Lane V/C Ratio	0.007	-	-	-	0.012
HCM Control Delay (s)	7.5	-	-	-	10.8
HCM Lane LOS	A	-	-	-	B
HCM 95th %tile Q(veh)	0	-	-	-	0

Intersection

Int Delay, s/veh 2

Movement	EBL	EBT	WBT	WBR	SBL	SBR
Lane Configurations						
Traffic Vol, veh/h	128	366	49	29	6	9
Future Vol, veh/h	128	366	49	29	6	9
Conflicting Peds, #/hr	0	0	0	0	0	0
Sign Control	Free	Free	Free	Free	Stop	Stop
RT Channelized	-	None	-	None	-	None
Storage Length	125	-	-	-	0	-
Veh in Median Storage, #	-	0	0	-	0	-
Grade, %	-	-1	1	-	-1	-
Peak Hour Factor	83	83	83	83	83	83
Heavy Vehicles, %	1	1	0	5	0	11
Mvmt Flow	154	441	59	35	7	11

Major/Minor	Major1	Major2	Minor2		
Conflicting Flow All	94	0	-	0	826 77
Stage 1	-	-	-	-	77 -
Stage 2	-	-	-	-	749 -
Critical Hdwy	4.11	-	-	-	6.2 6.21
Critical Hdwy Stg 1	-	-	-	-	5.2 -
Critical Hdwy Stg 2	-	-	-	-	5.2 -
Follow-up Hdwy	2.209	-	-	-	3.5 3.399
Pot Cap-1 Maneuver	1506	-	-	-	361 962
Stage 1	-	-	-	-	955 -
Stage 2	-	-	-	-	491 -
Platoon blocked, %		-	-	-	
Mov Cap-1 Maneuver	1506	-	-	-	324 962
Mov Cap-2 Maneuver	-	-	-	-	324 -
Stage 1	-	-	-	-	858 -
Stage 2	-	-	-	-	491 -

Approach	EB	WB	SB
HCM Control Delay, s	2	0	11.9
HCM LOS			B

Minor Lane/Major Mvmt	EBL	EBT	WBT	WBR	SBLn1
Capacity (veh/h)	1506	-	-	-	538
HCM Lane V/C Ratio	0.102	-	-	-	0.034
HCM Control Delay (s)	7.7	-	-	-	11.9
HCM Lane LOS	A	-	-	-	B
HCM 95th %tile Q(veh)	0.3	-	-	-	0.1

Intersection

Int Delay, s/veh 2.9

Movement	EBT	EBR	WBL	WBT	NBL	NBR
Lane Configurations	↑	↗		↖↑	↖	↗
Traffic Vol, veh/h	13	60	1	67	62	2
Future Vol, veh/h	13	60	1	67	62	2
Conflicting Peds, #/hr	0	0	0	0	0	0
Sign Control	Free	Free	Free	Free	Stop	Stop
RT Channelized	-	None	-	None	-	None
Storage Length	-	0	-	-	140	0
Veh in Median Storage, #	0	-	-	0	0	-
Grade, %	-2	-	-	1	0	-
Peak Hour Factor	82	82	82	82	82	82
Heavy Vehicles, %	17	2	2	3	0	0
Mvmt Flow	16	73	1	82	76	2

Major/Minor	Major1	Major2	Minor1
Conflicting Flow All	0	0	89
Stage 1	-	-	16
Stage 2	-	-	43
Critical Hdwy	-	4.13	6.6
Critical Hdwy Stg 1	-	-	5.4
Critical Hdwy Stg 2	-	-	5.8
Follow-up Hdwy	-	2.219	3.5
Pot Cap-1 Maneuver	-	1505	950
Stage 1	-	-	1012
Stage 2	-	-	980
Platoon blocked, %	-	-	-
Mov Cap-1 Maneuver	-	1505	949
Mov Cap-2 Maneuver	-	-	949
Stage 1	-	-	1012
Stage 2	-	-	979

Approach	EB	WB	NB
HCM Control Delay, s	0	0.1	9.1
HCM LOS			A

Minor Lane/Major Mvmt	NBLn1	NBLn2	EBT	EBR	WBL	WBT
Capacity (veh/h)	949	1069	-	-	1505	-
HCM Lane V/C Ratio	0.08	0.002	-	-	0.001	-
HCM Control Delay (s)	9.1	8.4	-	-	7.4	0
HCM Lane LOS	A	A	-	-	A	A
HCM 95th %tile Q(veh)	0.3	0	-	-	0	-



Lane Group	EBL	EBT	WBT	WBR	SBL	SBR
Lane Configurations						
Traffic Volume (vph)	232	325	568	986	127	23
Future Volume (vph)	232	325	568	986	127	23
Ideal Flow (vphpl)	1900	1900	1900	1900	1900	1900
Grade (%)		0%	-1%		0%	
Storage Length (ft)	220			0	125	125
Storage Lanes	1			1	2	0
Taper Length (ft)	25				25	
Satd. Flow (prot)	1787	1863	3592	1607	3502	1615
Flt Permitted	0.394				0.950	
Satd. Flow (perm)	741	1863	3592	1607	3502	1615
Right Turn on Red				Yes		Yes
Satd. Flow (RTOR)				812		24
Link Speed (mph)		25	25		25	
Link Distance (ft)		608	1114		279	
Travel Time (s)		16.6	30.4		7.6	
Peak Hour Factor	0.96	0.96	0.96	0.96	0.96	0.96
Heavy Vehicles (%)	1%	2%	1%	1%	0%	0%
Shared Lane Traffic (%)						
Lane Group Flow (vph)	242	339	592	1027	132	24
Turn Type	pm+pt	NA	NA	Free	Perm	Perm
Protected Phases	5	2	6			
Permitted Phases	2			Free	4	4
Total Split (s)	15.0	66.0	51.0		34.0	34.0
Total Lost Time (s)	3.0	6.0	6.0		6.0	6.0
Act Effct Green (s)	63.0	60.0	48.2	82.1	10.1	10.1
Actuated g/C Ratio	0.77	0.73	0.59	1.00	0.12	0.12
v/c Ratio	0.36	0.25	0.28	0.64	0.31	0.11
Control Delay	4.1	4.2	9.1	2.0	34.9	14.6
Queue Delay	0.0	0.0	0.0	0.0	0.0	0.0
Total Delay	4.1	4.2	9.1	2.0	34.9	14.6
LOS	A	A	A	A	C	B
Approach Delay		4.2	4.6		31.8	
Approach LOS		A	A		C	
Queue Length 50th (ft)	25	46	71	0	32	0
Queue Length 95th (ft)	45	76	109	0	58	21
Internal Link Dist (ft)		528	1034		199	
Turn Bay Length (ft)	220				125	125
Base Capacity (vph)	721	1361	2107	1607	1193	566
Starvation Cap Reductn	0	0	0	0	0	0
Spillback Cap Reductn	0	0	0	0	0	0
Storage Cap Reductn	0	0	0	0	0	0
Reduced v/c Ratio	0.34	0.25	0.28	0.64	0.11	0.04

Intersection Summary

Area Type: Other
 Cycle Length: 100
 Actuated Cycle Length: 82.1
 Control Type: Semi Act-Uncoord

Maximum v/c Ratio: 0.64

Intersection Signal Delay: 6.3

Intersection LOS: A

Intersection Capacity Utilization 72.0%

ICU Level of Service C

Analysis Period (min) 15

Splits and Phases: 10: Meadow Road & Route 1 SB Ramps



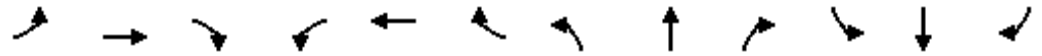

Lane Group	EBL	EBT	EBR	WBL	WBT	WBR	NBL	NBT	NBR	SBL	SBT	SBR
Lane Configurations												
Traffic Volume (vph)	71	278	103	117	710	46	143	26	117	210	12	701
Future Volume (vph)	71	278	103	117	710	46	143	26	117	210	12	701
Ideal Flow (vphpl)	1900	1900	1900	1900	1900	1900	1900	1900	1900	1900	1900	1900
Lane Width (ft)	12	12	12	12	12	12	12	11	11	13	13	16
Grade (%)		-5%			3%			3%			2%	
Storage Length (ft)	115		0	325		450	0		0	120		0
Storage Lanes	1		0	1		1	1		0	1		1
Taper Length (ft)	25			25			25			25		
Satd. Flow (prot)	1850	3517	0	1760	3556	1591	1760	1574	0	1828	1944	1794
Flt Permitted	0.321			0.480			0.702					
Satd. Flow (perm)	625	3517	0	889	3556	1591	1301	1574	0	1924	1944	1794
Right Turn on Red			Yes			Yes			Yes			Yes
Satd. Flow (RTOR)		52				87		123				426
Link Speed (mph)		25			25			25				25
Link Distance (ft)		1114			553			434				429
Travel Time (s)		30.4			15.1			11.8				11.7
Peak Hour Factor	0.95	0.95	0.95	0.95	0.95	0.95	0.95	0.95	0.95	0.95	0.95	0.95
Heavy Vehicles (%)	0%	1%	1%	1%	0%	0%	1%	0%	1%	1%	0%	1%
Shared Lane Traffic (%)												
Lane Group Flow (vph)	75	401	0	123	747	48	151	150	0	221	13	738
Turn Type	pm+pt	NA		pm+pt	NA	Perm	pm+pt	NA		pm+pt	NA	Free
Protected Phases	5	2		1	6		3	8		7	4	
Permitted Phases	2			6		6	8			4		Free
Total Split (s)	15.0	59.0		15.0	59.0	59.0	16.0	36.0		16.0	36.0	
Total Lost Time (s)	3.0	6.0		3.0	6.0	6.0	3.0	7.0		3.0	7.0	
Act Effct Green (s)	63.4	53.0		66.2	56.1	56.1	30.0	10.8		16.2	10.8	104.2
Actuated g/C Ratio	0.61	0.51		0.64	0.54	0.54	0.29	0.10		0.16	0.10	1.00
v/c Ratio	0.16	0.22		0.19	0.39	0.05	0.31	0.55		0.77	0.07	0.41
Control Delay	7.9	12.9		7.9	15.6	0.8	30.7	20.3		59.1	43.3	0.7
Queue Delay	0.0	0.0		0.0	0.0	0.0	0.0	0.0		0.0	0.0	0.0
Total Delay	7.9	12.9		7.9	15.6	0.8	30.7	20.3		59.1	43.3	0.7
LOS	A	B		A	B	A	C	C		E	D	A
Approach Delay		12.1			13.8			25.5			14.5	
Approach LOS		B			B			C			B	
Queue Length 50th (ft)	16	63		28	150	0	77	17		148	8	0
Queue Length 95th (ft)	36	103		55	217	5	135	79		190	27	0
Internal Link Dist (ft)		1034			473			354			349	
Turn Bay Length (ft)	115			325		450				120		
Base Capacity (vph)	544	1815		677	1913	896	492	527		291	541	1794
Starvation Cap Reductn	0	0		0	0	0	0	0		0	0	0
Spillback Cap Reductn	0	0		0	0	0	0	0		0	0	0
Storage Cap Reductn	0	0		0	0	0	0	0		0	0	0
Reduced v/c Ratio	0.14	0.22		0.18	0.39	0.05	0.31	0.28		0.76	0.02	0.41

Intersection Summary

Area Type: Other

Cycle Length: 126

Actuated Cycle Length: 104.2

Control Type: Semi Act-Uncoord

Maximum v/c Ratio: 0.77

Intersection Signal Delay: 15.1









Intersection LOS: B

Intersection Capacity Utilization 88.4%

ICU Level of Service E

Analysis Period (min) 15

Splits and Phases: 20: Old Meadow Rd/Route 1 NB Ramps & Meadow Road

 Ø1	 Ø2	 Ø3	 Ø4
15 s	59 s	16 s	36 s
 Ø5	 Ø6	 Ø7	 Ø8
15 s	59 s	16 s	36 s

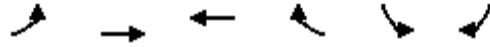

Lane Group	EBL	EBT	WBT	WBR	SBL	SBR
Lane Configurations						
Traffic Volume (vph)	287	552	179	77	118	147
Future Volume (vph)	287	552	179	77	118	147
Ideal Flow (vphpl)	1900	1900	1900	1900	1900	1900
Lane Width (ft)	12	12	11	13	11	11
Grade (%)		1%	0%		0%	
Storage Length (ft)	190			155	265	0
Storage Lanes	1			1	1	1
Taper Length (ft)	25				25	
Satd. Flow (prot)	1778	1872	1801	1652	1745	1561
Flt Permitted	0.633				0.950	
Satd. Flow (perm)	1185	1872	1801	1652	1745	1561
Right Turn on Red				Yes		Yes
Satd. Flow (RTOR)						163
Link Speed (mph)		25	25		25	
Link Distance (ft)		2245	457		697	
Travel Time (s)		61.2	12.5		19.0	
Peak Hour Factor	0.90	0.90	0.90	0.90	0.90	0.90
Heavy Vehicles (%)	1%	1%	2%	1%	0%	0%
Shared Lane Traffic (%)						
Lane Group Flow (vph)	319	613	199	86	131	163
Turn Type	Perm	NA	NA	pm+ov	Prot	Prot
Protected Phases		2	6	4	4	8
Permitted Phases	2			6		
Total Split (s)	55.0	55.0	55.0	35.0	35.0	35.0
Total Lost Time (s)	5.0	5.0	5.0	5.0	5.0	5.0
Act Effct Green (s)	50.0	50.0	50.0	70.9	10.8	10.8
Actuated g/C Ratio	0.71	0.71	0.71	1.00	0.15	0.15
v/c Ratio	0.38	0.46	0.16	0.05	0.49	0.43
Control Delay	6.3	6.4	4.2	0.1	33.9	8.7
Queue Delay	0.0	0.0	0.0	0.0	0.0	0.0
Total Delay	6.3	6.4	4.2	0.1	33.9	8.7
LOS	A	A	A	A	C	A
Approach Delay		6.4	3.0		19.9	
Approach LOS		A	A		B	
Queue Length 50th (ft)	45	94	23	0	53	0
Queue Length 95th (ft)	103	187	52	0	102	47
Internal Link Dist (ft)		2165	377		617	
Turn Bay Length (ft)	190			155	265	
Base Capacity (vph)	836	1321	1271	1652	739	755
Starvation Cap Reductn	0	0	0	0	0	0
Spillback Cap Reductn	0	0	0	0	0	0
Storage Cap Reductn	0	0	0	0	0	0
Reduced v/c Ratio	0.38	0.46	0.16	0.05	0.18	0.22

Intersection Summary

Area Type: Other

Cycle Length: 90

Actuated Cycle Length: 70.9

Control Type: Semi Act-Uncoord

Maximum v/c Ratio: 0.49

Intersection Signal Delay: 8.4

Intersection LOS: A

Intersection Capacity Utilization 102.4%

ICU Level of Service G

Analysis Period (min) 15

Splits and Phases: 40: Meadow Road & Bear Brook Road

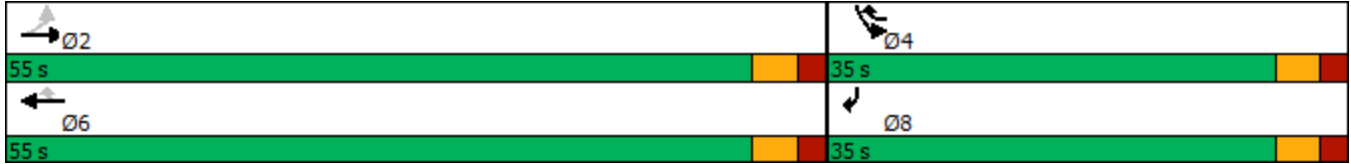

Intersection

Int Delay, s/veh 3.3

Movement	EBT	EBR	WBL	WBT	NBL	NBR
Lane Configurations	↑			↑		↑
Traffic Vol, veh/h	72	0	0	87	0	89
Future Vol, veh/h	72	0	0	87	0	89
Conflicting Peds, #/hr	0	0	0	0	0	0
Sign Control	Free	Free	Free	Free	Stop	Stop
RT Channelized	-	None	-	None	-	Yield
Storage Length	-	-	-	-	-	0
Veh in Median Storage, #	0	-	-	0	0	-
Grade, %	0	-	-	0	0	-
Peak Hour Factor	90	90	90	90	90	90
Heavy Vehicles, %	2	2	2	2	2	2
Mvmt Flow	80	0	0	97	0	99

Major/Minor	Major1	Major2	Minor1
Conflicting Flow All	0	-	-
Stage 1	-	-	-
Stage 2	-	-	-
Critical Hdwy	-	-	-
Critical Hdwy Stg 1	-	-	-
Critical Hdwy Stg 2	-	-	-
Follow-up Hdwy	-	-	-
Pot Cap-1 Maneuver	-	0	0
Stage 1	-	0	0
Stage 2	-	0	0
Platoon blocked, %	-	-	-
Mov Cap-1 Maneuver	-	-	-
Mov Cap-2 Maneuver	-	-	-
Stage 1	-	-	-
Stage 2	-	-	-

Approach	EB	WB	NB
HCM Control Delay, s	0	0	9.1
HCM LOS			A

Minor Lane/Major Mvmt	NBLn1	EBT	WBT
Capacity (veh/h)	980	-	-
HCM Lane V/C Ratio	0.101	-	-
HCM Control Delay (s)	9.1	-	-
HCM Lane LOS	A	-	-
HCM 95th %tile Q(veh)	0.3	-	-

Intersection

Int Delay, s/veh 23.1

Movement	EBL	EBT	WBT	WBR	SBL	SBR
Lane Configurations	↘	↗	↗	↘	↘	↘
Traffic Vol, veh/h	26	579	312	14	260	561
Future Vol, veh/h	26	579	312	14	260	561
Conflicting Peds, #/hr	0	0	0	0	0	0
Sign Control	Free	Free	Free	Free	Stop	Stop
RT Channelized	-	None	-	None	-	None
Storage Length	250	-	-	135	0	0
Veh in Median Storage, #	-	0	0	-	0	-
Grade, %	-	0	2	-	-1	-
Peak Hour Factor	94	94	94	94	94	94
Heavy Vehicles, %	0	1	0	0	0	0
Mvmt Flow	28	616	332	15	277	597

Major/Minor	Major1	Major2	Minor2
Conflicting Flow All	347	0	0
Stage 1	-	-	-
Stage 2	-	-	-
Critical Hdwy	4.1	-	-
Critical Hdwy Stg 1	-	-	-
Critical Hdwy Stg 2	-	-	-
Follow-up Hdwy	2.2	-	-
Pot Cap-1 Maneuver	1223	-	-
Stage 1	-	-	-
Stage 2	-	-	-
Platoon blocked, %	-	-	-
Mov Cap-1 Maneuver	1223	-	-
Mov Cap-2 Maneuver	-	-	-
Stage 1	-	-	-
Stage 2	-	-	-

Approach	EB	WB	SB
HCM Control Delay, s	0.3	0	49.1
HCM LOS			E

Minor Lane/Major Mvmt	EBL	EBT	WBT	WBR	SBLn1	SBLn2
Capacity (veh/h)	1223	-	-	-	279	721
HCM Lane V/C Ratio	0.023	-	-	-	0.991	0.828
HCM Control Delay (s)	8	-	-	-	91.9	29.2
HCM Lane LOS	A	-	-	-	F	D
HCM 95th %tile Q(veh)	0.1	-	-	-	10	9.1

Intersection						
Int Delay, s/veh	6.8					
Movement	EBL	EBR	NBL	NBT	SBT	SBR
Lane Configurations	↙	↗	↙	↑	↗	
Traffic Vol, veh/h	44	236	13	27	585	22
Future Vol, veh/h	44	236	13	27	585	22
Conflicting Peds, #/hr	0	0	0	0	0	0
Sign Control	Stop	Stop	Free	Free	Free	Free
RT Channelized	-	None	-	None	-	None
Storage Length	100	0	0	-	-	-
Veh in Median Storage, #	0	-	-	0	0	-
Grade, %	1	-	-	-2	1	-
Peak Hour Factor	90	90	90	90	90	90
Heavy Vehicles, %	2	1	0	0	0	5
Mvmt Flow	49	262	14	30	650	24

Major/Minor	Minor2	Major1	Major2			
Conflicting Flow All	720	662	674	0	-	0
Stage 1	662	-	-	-	-	-
Stage 2	58	-	-	-	-	-
Critical Hdwy	6.62	6.31	4.1	-	-	-
Critical Hdwy Stg 1	5.62	-	-	-	-	-
Critical Hdwy Stg 2	5.62	-	-	-	-	-
Follow-up Hdwy	3.518	3.309	2.2	-	-	-
Pot Cap-1 Maneuver	379	455	927	-	-	-
Stage 1	494	-	-	-	-	-
Stage 2	961	-	-	-	-	-
Platoon blocked, %				-	-	-
Mov Cap-1 Maneuver	373	455	927	-	-	-
Mov Cap-2 Maneuver	373	-	-	-	-	-
Stage 1	487	-	-	-	-	-
Stage 2	961	-	-	-	-	-

Approach	EB	NB	SB
HCM Control Delay, s	22	2.9	0
HCM LOS	C		

Minor Lane/Major Mvmt	NBL	NBT	EBLn1	EBLn2	SBT	SBR
Capacity (veh/h)	927	-	373	455	-	-
HCM Lane V/C Ratio	0.016	-	0.131	0.576	-	-
HCM Control Delay (s)	8.9	-	16.1	23.1	-	-
HCM Lane LOS	A	-	C	C	-	-
HCM 95th %tile Q(veh)	0	-	0.4	3.6	-	-

Intersection

Int Delay, s/veh 1.7

Movement	EBL	EBT	WBT	WBR	SBL	SBR
Lane Configurations						
Traffic Vol, veh/h	11	228	40	10	34	15
Future Vol, veh/h	11	228	40	10	34	15
Conflicting Peds, #/hr	0	0	0	0	0	0
Sign Control	Free	Free	Free	Free	Stop	Stop
RT Channelized	-	None	-	None	-	None
Storage Length	125	-	-	-	0	-
Veh in Median Storage, #	-	0	0	-	0	-
Grade, %	-	-1	1	-	0	-
Peak Hour Factor	90	90	90	90	90	90
Heavy Vehicles, %	9	2	0	10	3	0
Mvmt Flow	12	253	44	11	38	17

Major/Minor	Major1	Major2	Minor2
Conflicting Flow All	55	0	0
Stage 1	-	-	50
Stage 2	-	-	277
Critical Hdwy	4.19	-	6.43
Critical Hdwy Stg 1	-	-	5.43
Critical Hdwy Stg 2	-	-	5.43
Follow-up Hdwy	2.281	-	3.527
Pot Cap-1 Maneuver	1506	-	665
Stage 1	-	-	970
Stage 2	-	-	767
Platoon blocked, %	-	-	-
Mov Cap-1 Maneuver	1506	-	660
Mov Cap-2 Maneuver	-	-	660
Stage 1	-	-	962
Stage 2	-	-	767

Approach	EB	WB	SB
HCM Control Delay, s	0.3	0	10.2
HCM LOS			B

Minor Lane/Major Mvmt	EBL	EBT	WBT	WBR	SBLn1
Capacity (veh/h)	1506	-	-	-	741
HCM Lane V/C Ratio	0.008	-	-	-	0.073
HCM Control Delay (s)	7.4	-	-	-	10.2
HCM Lane LOS	A	-	-	-	B
HCM 95th %tile Q(veh)	0	-	-	-	0.2

Intersection

Int Delay, s/veh 0.7

Movement	EBL	EBT	WBT	WBR	SBL	SBR
Lane Configurations						
Traffic Vol, veh/h	2	222	43	12	17	1
Future Vol, veh/h	2	222	43	12	17	1
Conflicting Peds, #/hr	0	0	0	0	0	0
Sign Control	Free	Free	Free	Free	Stop	Stop
RT Channelized	-	None	-	None	-	None
Storage Length	125	-	-	-	0	-
Veh in Median Storage, #	-	0	0	-	0	-
Grade, %	-	-1	1	-	0	-
Peak Hour Factor	90	90	90	90	90	90
Heavy Vehicles, %	0	0	0	0	0	0
Mvmt Flow	2	247	48	13	19	1

Major/Minor	Major1	Major2	Minor2		
Conflicting Flow All	61	0	-	0	306 55
Stage 1	-	-	-	-	55 -
Stage 2	-	-	-	-	251 -
Critical Hdwy	4.1	-	-	-	6.4 6.2
Critical Hdwy Stg 1	-	-	-	-	5.4 -
Critical Hdwy Stg 2	-	-	-	-	5.4 -
Follow-up Hdwy	2.2	-	-	-	3.5 3.3
Pot Cap-1 Maneuver	1555	-	-	-	690 1018
Stage 1	-	-	-	-	973 -
Stage 2	-	-	-	-	795 -
Platoon blocked, %		-	-	-	
Mov Cap-1 Maneuver	1555	-	-	-	689 1018
Mov Cap-2 Maneuver	-	-	-	-	689 -
Stage 1	-	-	-	-	972 -
Stage 2	-	-	-	-	795 -

Approach	EB	WB	SB
HCM Control Delay, s	0.1	0	10.3
HCM LOS			B

Minor Lane/Major Mvmt	EBL	EBT	WBT	WBR	SBLn1
Capacity (veh/h)	1555	-	-	-	702
HCM Lane V/C Ratio	0.001	-	-	-	0.028
HCM Control Delay (s)	7.3	-	-	-	10.3
HCM Lane LOS	A	-	-	-	B
HCM 95th %tile Q(veh)	0	-	-	-	0.1

Intersection

Int Delay, s/veh 3.9

Movement	EBL	EBT	WBT	WBR	SBL	SBR
Lane Configurations	↘	↑	↗		↘	
Traffic Vol, veh/h	8	151	40	4	73	49
Future Vol, veh/h	8	151	40	4	73	49
Conflicting Peds, #/hr	0	0	0	0	0	0
Sign Control	Free	Free	Free	Free	Stop	Stop
RT Channelized	-	None	-	None	-	None
Storage Length	125	-	-	-	0	-
Veh in Median Storage, #	-	0	0	-	0	-
Grade, %	-	-1	1	-	-1	-
Peak Hour Factor	90	90	90	90	90	90
Heavy Vehicles, %	13	2	0	0	0	2
Mvmt Flow	9	168	44	4	81	54

Major/Minor	Major1	Major2	Minor2		
Conflicting Flow All	48	0	-	0	232 46
Stage 1	-	-	-	-	46 -
Stage 2	-	-	-	-	186 -
Critical Hdwy	4.23	-	-	-	6.2 6.12
Critical Hdwy Stg 1	-	-	-	-	5.2 -
Critical Hdwy Stg 2	-	-	-	-	5.2 -
Follow-up Hdwy	2.317	-	-	-	3.5 3.318
Pot Cap-1 Maneuver	1491	-	-	-	770 1025
Stage 1	-	-	-	-	984 -
Stage 2	-	-	-	-	859 -
Platoon blocked, %		-	-	-	
Mov Cap-1 Maneuver	1491	-	-	-	765 1025
Mov Cap-2 Maneuver	-	-	-	-	765 -
Stage 1	-	-	-	-	978 -
Stage 2	-	-	-	-	859 -

Approach	EB	WB	SB
HCM Control Delay, s	0.4	0	10
HCM LOS			B

Minor Lane/Major Mvmt	EBL	EBT	WBT	WBR	SBLn1
Capacity (veh/h)	1491	-	-	-	852
HCM Lane V/C Ratio	0.006	-	-	-	0.159
HCM Control Delay (s)	7.4	-	-	-	10
HCM Lane LOS	A	-	-	-	B
HCM 95th %tile Q(veh)	0	-	-	-	0.6

Intersection

Int Delay, s/veh 5

Movement	EBT	EBR	WBL	WBT	NBL	NBR
Lane Configurations	↑	↗		↖↑	↖	↗
Traffic Vol, veh/h	45	187	3	43	243	13
Future Vol, veh/h	45	187	3	43	243	13
Conflicting Peds, #/hr	0	0	0	0	0	0
Sign Control	Free	Free	Free	Free	Stop	Stop
RT Channelized	-	None	-	None	-	None
Storage Length	-	0	-	-	140	0
Veh in Median Storage, #	0	-	-	0	0	-
Grade, %	-2	-	-	1	0	-
Peak Hour Factor	94	94	94	94	94	94
Heavy Vehicles, %	2	0	0	3	0	0
Mvmt Flow	48	199	3	46	259	14

Major/Minor	Major1	Major2	Minor1
Conflicting Flow All	0	0	247
Stage 1	-	-	-
Stage 2	-	-	-
Critical Hdwy	-	-	4.1
Critical Hdwy Stg 1	-	-	-
Critical Hdwy Stg 2	-	-	-
Follow-up Hdwy	-	-	2.2
Pot Cap-1 Maneuver	-	-	1331
Stage 1	-	-	-
Stage 2	-	-	-
Platoon blocked, %	-	-	-
Mov Cap-1 Maneuver	-	-	1331
Mov Cap-2 Maneuver	-	-	-
Stage 1	-	-	-
Stage 2	-	-	-

Approach	EB	WB	NB
HCM Control Delay, s	0	0.5	10.3
HCM LOS			B

Minor Lane/Major Mvmt	NBLn1	NBLn2	EBT	EBR	WBL	WBT
Capacity (veh/h)	925	1027	-	-	1331	-
HCM Lane V/C Ratio	0.279	0.013	-	-	0.002	-
HCM Control Delay (s)	10.4	8.6	-	-	7.7	0
HCM Lane LOS	B	A	-	-	A	A
HCM 95th %tile Q(veh)	1.1	0	-	-	0	-



Lane Group	EBL	EBT	WBT	WBR	SBL	SBR
Lane Configurations	↶	↷	↶↷	↷	↶↷	↷
Traffic Volume (vph)	56	156	636	487	77	11
Future Volume (vph)	56	156	636	487	77	11
Ideal Flow (vphpl)	1900	1900	1900	1900	1900	1900
Grade (%)		0%	-1%		0%	
Storage Length (ft)	220			0	125	125
Storage Lanes	1			1	2	0
Taper Length (ft)	25				25	
Satd. Flow (prot)	1656	1792	3592	1576	3367	1553
Flt Permitted	0.374				0.950	
Satd. Flow (perm)	652	1792	3592	1576	3367	1553
Right Turn on Red				Yes		Yes
Satd. Flow (RTOR)				507		11
Link Speed (mph)		25	25		25	
Link Distance (ft)		608	1114		279	
Travel Time (s)		16.6	30.4		7.6	
Peak Hour Factor	0.96	0.96	0.96	0.96	0.96	0.96
Heavy Vehicles (%)	9%	6%	1%	3%	4%	4%
Shared Lane Traffic (%)						
Lane Group Flow (vph)	58	163	663	507	80	11
Turn Type	pm+pt	NA	NA	Free	Perm	Perm
Protected Phases	5	2	6			
Permitted Phases	2			Free	4	4
Total Split (s)	15.0	66.0	51.0		34.0	34.0
Total Lost Time (s)	3.0	6.0	6.0		6.0	6.0
Act Effct Green (s)	66.0	64.2	56.6	81.8	10.0	10.0
Actuated g/C Ratio	0.81	0.78	0.69	1.00	0.12	0.12
v/c Ratio	0.10	0.12	0.27	0.32	0.19	0.06
Control Delay	2.6	3.3	6.9	0.5	33.7	18.1
Queue Delay	0.0	0.0	0.0	0.0	0.0	0.0
Total Delay	2.6	3.3	6.9	0.5	33.7	18.1
LOS	A	A	A	A	C	B
Approach Delay		3.1	4.2		31.8	
Approach LOS		A	A		C	
Queue Length 50th (ft)	5	20	75	0	19	0
Queue Length 95th (ft)	12	36	106	0	39	15
Internal Link Dist (ft)		528	1034		199	
Turn Bay Length (ft)	220				125	125
Base Capacity (vph)	673	1407	2484	1576	1152	538
Starvation Cap Reductn	0	0	0	0	0	0
Spillback Cap Reductn	0	0	0	0	0	0
Storage Cap Reductn	0	0	0	0	0	0
Reduced v/c Ratio	0.09	0.12	0.27	0.32	0.07	0.02

Intersection Summary

Area Type: Other
 Cycle Length: 100
 Actuated Cycle Length: 81.8
 Control Type: Semi Act-Uncoord

Maximum v/c Ratio: 0.32

Intersection Signal Delay: 5.7

Intersection LOS: A

Intersection Capacity Utilization 63.3%

ICU Level of Service B

Analysis Period (min) 15

Splits and Phases: 10: Meadow Road & Route 1 SB Ramps



Lane Group	EBL	EBT	EBR	WBL	WBT	WBR	NBL	NBT	NBR	SBL	SBT	SBR
Lane Configurations												
Traffic Volume (vph)	43	153	37	36	438	45	56	20	58	112	2	629
Future Volume (vph)	43	153	37	36	438	45	56	20	58	112	2	629
Ideal Flow (vphpl)	1900	1900	1900	1900	1900	1900	1900	1900	1900	1900	1900	1900
Lane Width (ft)	12	12	12	12	12	12	12	11	11	13	13	16
Grade (%)		-5%			3%			3%			2%	
Storage Length (ft)	115		0	325		450	0		0	120		0
Storage Lanes	1		0	1		1	1		0	1		1
Taper Length (ft)	25			25			25			25		
Satd. Flow (prot)	1814	3442	0	1726	3521	1560	1710	1530	0	1775	1944	1794
Flt Permitted	0.474			0.626			0.500			0.800		
Satd. Flow (perm)	905	3442	0	1137	3521	1560	900	1530	0	1495	1944	1794
Right Turn on Red			Yes			Yes			Yes			Yes
Satd. Flow (RTOR)		29				87		61				600
Link Speed (mph)		25			25			25				25
Link Distance (ft)		1114			551			434				429
Travel Time (s)		30.4			15.0			11.8				11.7
Peak Hour Factor	0.95	0.95	0.95	0.95	0.95	0.95	0.95	0.95	0.95	0.95	0.95	0.95
Heavy Vehicles (%)	2%	4%	6%	3%	1%	2%	4%	5%	5%	4%	0%	1%
Shared Lane Traffic (%)												
Lane Group Flow (vph)	45	200	0	38	461	47	59	82	0	118	2	662
Turn Type	pm+pt	NA		pm+pt	NA	Perm	pm+pt	NA		pm+pt	NA	Free
Protected Phases	5	2		1	6		3	8		7	4	
Permitted Phases	2			6		6	8			4		Free
Total Split (s)	15.0	59.0		15.0	59.0	59.0	16.0	36.0		16.0	36.0	
Total Lost Time (s)	3.0	6.0		3.0	6.0	6.0	3.0	7.0		3.0	7.0	
Act Effct Green (s)	60.9	53.9		60.7	53.8	53.8	23.1	10.4		16.0	10.8	94.6
Actuated g/C Ratio	0.64	0.57		0.64	0.57	0.57	0.24	0.11		0.17	0.11	1.00
v/c Ratio	0.07	0.10		0.05	0.23	0.05	0.15	0.37		0.41	0.01	0.37
Control Delay	7.0	9.9		6.9	12.2	0.8	27.2	22.1		40.2	40.5	0.6
Queue Delay	0.0	0.0		0.0	0.0	0.0	0.0	0.0		0.0	0.0	0.0
Total Delay	7.0	9.9		6.9	12.2	0.8	27.2	22.1		40.2	40.5	0.6
LOS	A	A		A	B	A	C	C		D	D	A
Approach Delay		9.4			10.9			24.2				6.7
Approach LOS		A			B			C				A
Queue Length 50th (ft)	9	27		8	81	0	28	13		73	1	0
Queue Length 95th (ft)	23	48		20	120	5	60	59		105	8	0
Internal Link Dist (ft)		1034			471			354				349
Turn Bay Length (ft)	115			325		450				120		
Base Capacity (vph)	714	1972		826	2001	924	432	517		302	604	1794
Starvation Cap Reductn	0	0		0	0	0	0	0		0	0	0
Spillback Cap Reductn	0	0		0	0	0	0	0		0	0	0
Storage Cap Reductn	0	0		0	0	0	0	0		0	0	0
Reduced v/c Ratio	0.06	0.10		0.05	0.23	0.05	0.14	0.16		0.39	0.00	0.37
Intersection Summary												
Area Type:	Other											
Cycle Length:	126											
Actuated Cycle Length:	94.6											

Control Type: Semi Act-Uncoord

Maximum v/c Ratio: 0.41

Intersection Signal Delay: 9.8





Intersection LOS: A

Intersection Capacity Utilization 70.8%

ICU Level of Service C

Analysis Period (min) 15

Splits and Phases: 20: Old Meadow Rd/Route 1 NB Ramps & Meadow Road

 Ø1	 Ø2	 Ø3	 Ø4
15 s	59 s	16 s	36 s
 Ø5	 Ø6	 Ø7	 Ø8
15 s	59 s	16 s	36 s

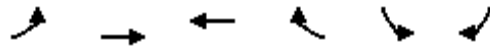

Lane Group	EBL	EBT	WBT	WBR	SBL	SBR
Lane Configurations						
Traffic Volume (vph)	123	115	446	80	50	271
Future Volume (vph)	123	115	446	80	50	271
Ideal Flow (vphpl)	1900	1900	1900	1900	1900	1900
Lane Width (ft)	12	12	11	13	11	11
Grade (%)		1%	0%		0%	
Storage Length (ft)	190			155	265	0
Storage Lanes	1			1	1	1
Taper Length (ft)	25				25	
Satd. Flow (prot)	1727	1750	1818	1560	1517	1531
Flt Permitted	0.471				0.950	
Satd. Flow (perm)	856	1750	1818	1560	1517	1531
Right Turn on Red				Yes		Yes
Satd. Flow (RTOR)						291
Link Speed (mph)		25	25		25	
Link Distance (ft)		2245	457		697	
Travel Time (s)		61.2	12.5		19.0	
Peak Hour Factor	0.93	0.93	0.93	0.93	0.93	0.93
Heavy Vehicles (%)	4%	8%	1%	7%	15%	2%
Shared Lane Traffic (%)						
Lane Group Flow (vph)	132	124	480	86	54	291
Turn Type	Perm	NA	NA	pm+ov	Prot	Prot
Protected Phases		2	6	4	4	8
Permitted Phases	2			6		
Total Split (s)	55.0	55.0	55.0	35.0	35.0	35.0
Total Lost Time (s)	5.0	5.0	5.0	5.0	5.0	5.0
Act Effct Green (s)	50.1	50.1	50.1	69.0	8.9	8.9
Actuated g/C Ratio	0.73	0.73	0.73	1.00	0.13	0.13
v/c Ratio	0.21	0.10	0.36	0.06	0.28	0.65
Control Delay	4.5	3.4	4.8	0.1	30.6	11.2
Queue Delay	0.0	0.0	0.0	0.0	0.0	0.0
Total Delay	4.5	3.4	4.8	0.1	30.6	11.2
LOS	A	A	A	A	C	B
Approach Delay		4.0	4.1		14.2	
Approach LOS		A	A		B	
Queue Length 50th (ft)	13	11	55	0	21	0
Queue Length 95th (ft)	40	32	127	0	51	61
Internal Link Dist (ft)		2165	377		617	
Turn Bay Length (ft)	190			155	265	
Base Capacity (vph)	621	1270	1319	1560	660	831
Starvation Cap Reductn	0	0	0	0	0	0
Spillback Cap Reductn	0	0	0	0	0	0
Storage Cap Reductn	0	0	0	0	0	0
Reduced v/c Ratio	0.21	0.10	0.36	0.06	0.08	0.35

Intersection Summary

Area Type: Other

Cycle Length: 90

Actuated Cycle Length: 69

Control Type: Semi Act-Uncoord

Maximum v/c Ratio: 0.65

Intersection Signal Delay: 7.0

Intersection LOS: A

Intersection Capacity Utilization 101.7%

ICU Level of Service G

Analysis Period (min) 15

Splits and Phases: 40: Meadow Road & Bear Brook Road

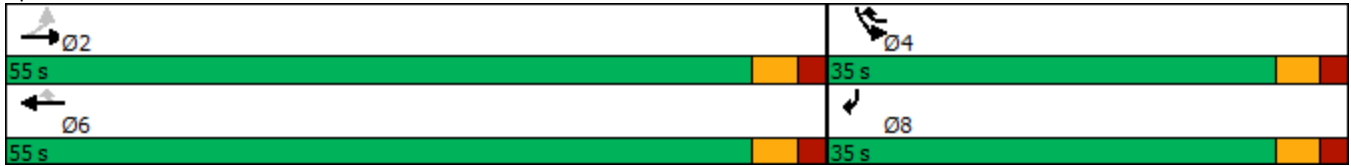

Intersection						
Int Delay, s/veh	9.5					
Movement	EBT	EBR	WBL	WBT	NBL	NBR
Lane Configurations	↑			↑		↑
Traffic Vol, veh/h	70	0	0	60	0	444
Future Vol, veh/h	70	0	0	60	0	444
Conflicting Peds, #/hr	0	0	0	0	0	0
Sign Control	Free	Free	Free	Free	Stop	Stop
RT Channelized	-	None	-	None	-	Yield
Storage Length	-	-	-	-	-	0
Veh in Median Storage, #	0	-	-	0	0	-
Grade, %	0	-	-	0	0	-
Peak Hour Factor	90	90	90	90	90	90
Heavy Vehicles, %	2	2	2	2	2	2
Mvmt Flow	78	0	0	67	0	493

Major/Minor	Major1	Major2	Minor1	Minor2
Conflicting Flow All	0	-	-	78
Stage 1	-	-	-	-
Stage 2	-	-	-	-
Critical Hdwy	-	-	-	6.22
Critical Hdwy Stg 1	-	-	-	-
Critical Hdwy Stg 2	-	-	-	-
Follow-up Hdwy	-	-	-	3.318
Pot Cap-1 Maneuver	-	0	0	983
Stage 1	-	0	0	-
Stage 2	-	0	0	-
Platoon blocked, %	-	-	-	-
Mov Cap-1 Maneuver	-	-	-	983
Mov Cap-2 Maneuver	-	-	-	-
Stage 1	-	-	-	-
Stage 2	-	-	-	-

Approach	EB	WB	NB
HCM Control Delay, s	0	0	12.3
HCM LOS			B

Minor Lane/Major Mvmt	NBLn1	EBT	WBT
Capacity (veh/h)	983	-	-
HCM Lane V/C Ratio	0.502	-	-
HCM Control Delay (s)	12.3	-	-
HCM Lane LOS	B	-	-
HCM 95th %tile Q(veh)	2.9	-	-

Intersection

Int Delay, s/veh 1.6

Movement	EBL	EBT	WBT	WBR	SBL	SBR
Lane Configurations	↘	↗	↗	↘	↘	↘
Traffic Vol, veh/h	100	223	479	238	15	42
Future Vol, veh/h	100	223	479	238	15	42
Conflicting Peds, #/hr	0	0	0	0	0	0
Sign Control	Free	Free	Free	Free	Stop	Stop
RT Channelized	-	None	-	None	-	None
Storage Length	250	-	-	135	0	0
Veh in Median Storage, #	-	0	0	-	0	-
Grade, %	-	0	2	-	-1	-
Peak Hour Factor	94	94	94	94	94	94
Heavy Vehicles, %	0	6	1	0	0	0
Mvmt Flow	106	237	510	253	16	45

Major/Minor	Major1	Major2	Minor2
Conflicting Flow All	763	0	0
Stage 1	-	-	510
Stage 2	-	-	449
Critical Hdwy	4.1	-	6.2
Critical Hdwy Stg 1	-	-	5.2
Critical Hdwy Stg 2	-	-	5.2
Follow-up Hdwy	2.2	-	3.5
Pot Cap-1 Maneuver	859	-	303
Stage 1	-	-	625
Stage 2	-	-	664
Platoon blocked, %	-	-	-
Mov Cap-1 Maneuver	859	-	266
Mov Cap-2 Maneuver	-	-	266
Stage 1	-	-	548
Stage 2	-	-	664

Approach	EB	WB	SB
HCM Control Delay, s	3	0	13.8
HCM LOS			B

Minor Lane/Major Mvmt	EBL	EBT	WBT	WBR	SBLn1	SBLn2
Capacity (veh/h)	859	-	-	-	266	576
HCM Lane V/C Ratio	0.124	-	-	-	0.06	0.078
HCM Control Delay (s)	9.8	-	-	-	19.4	11.8
HCM Lane LOS	A	-	-	-	C	B
HCM 95th %tile Q(veh)	0.4	-	-	-	0.2	0.3

Intersection						
Int Delay, s/veh	14.3					
Movement	EBL	EBR	NBL	NBT	SBT	SBR
Lane Configurations						
Traffic Vol, veh/h	289	20	129	209	37	30
Future Vol, veh/h	289	20	129	209	37	30
Conflicting Peds, #/hr	0	0	0	0	0	0
Sign Control	Stop	Stop	Free	Free	Free	Free
RT Channelized	-	None	-	None	-	None
Storage Length	100	0	0	-	-	-
Veh in Median Storage, #	0	-	-	0	0	-
Grade, %	1	-	-	-2	1	-
Peak Hour Factor	93	93	93	93	93	93
Heavy Vehicles, %	0	0	0	0	0	0
Mvmt Flow	311	22	139	225	40	32

Major/Minor	Minor2	Major1		Major2	
Conflicting Flow All	559	56	72	0	0
Stage 1	56	-	-	-	-
Stage 2	503	-	-	-	-
Critical Hdwy	6.6	6.3	4.1	-	-
Critical Hdwy Stg 1	5.6	-	-	-	-
Critical Hdwy Stg 2	5.6	-	-	-	-
Follow-up Hdwy	3.5	3.3	2.2	-	-
Pot Cap-1 Maneuver	478	1015	1541	-	-
Stage 1	969	-	-	-	-
Stage 2	595	-	-	-	-
Platoon blocked, %				-	-
Mov Cap-1 Maneuver	435	1015	1541	-	-
Mov Cap-2 Maneuver	435	-	-	-	-
Stage 1	882	-	-	-	-
Stage 2	595	-	-	-	-

Approach	EB	NB	SB
HCM Control Delay, s	29.9	2.9	0
HCM LOS	D		

Minor Lane/Major Mvmt	NBL	NBT	EBLn1	EBLn2	SBT	SBR
Capacity (veh/h)	1541	-	435	1015	-	-
HCM Lane V/C Ratio	0.09	-	0.714	0.021	-	-
HCM Control Delay (s)	7.6	-	31.4	8.6	-	-
HCM Lane LOS	A	-	D	A	-	-
HCM 95th %tile Q(veh)	0.3	-	5.5	0.1	-	-

Intersection						
Int Delay, s/veh	0.8					
Movement	EBL	EBT	WBT	WBR	SBL	SBR
Lane Configurations						
Traffic Vol, veh/h	36	345	128	16	10	6
Future Vol, veh/h	36	345	128	16	10	6
Conflicting Peds, #/hr	0	0	0	0	0	0
Sign Control	Free	Free	Free	Free	Stop	Stop
RT Channelized	-	None	-	None	-	None
Storage Length	125	-	-	-	0	-
Veh in Median Storage, #	-	0	0	-	0	-
Grade, %	-	-1	1	-	0	-
Peak Hour Factor	90	90	90	90	90	90
Heavy Vehicles, %	3	0	0	0	0	0
Mvmt Flow	40	383	142	18	11	7

Major/Minor	Major1	Major2	Minor2		
Conflicting Flow All	160	0	-	0	614 151
Stage 1	-	-	-	-	151 -
Stage 2	-	-	-	-	463 -
Critical Hdwy	4.13	-	-	-	6.4 6.2
Critical Hdwy Stg 1	-	-	-	-	5.4 -
Critical Hdwy Stg 2	-	-	-	-	5.4 -
Follow-up Hdwy	2.227	-	-	-	3.5 3.3
Pot Cap-1 Maneuver	1413	-	-	-	459 901
Stage 1	-	-	-	-	882 -
Stage 2	-	-	-	-	638 -
Platoon blocked, %		-	-	-	
Mov Cap-1 Maneuver	1413	-	-	-	446 901
Mov Cap-2 Maneuver	-	-	-	-	446 -
Stage 1	-	-	-	-	857 -
Stage 2	-	-	-	-	638 -

Approach	EB	WB	SB
HCM Control Delay, s	0.7	0	11.8
HCM LOS			B

Minor Lane/Major Mvmt	EBL	EBT	WBT	WBR	SBLn1
Capacity (veh/h)	1413	-	-	-	550
HCM Lane V/C Ratio	0.028	-	-	-	0.032
HCM Control Delay (s)	7.6	-	-	-	11.8
HCM Lane LOS	A	-	-	-	B
HCM 95th %tile Q(veh)	0.1	-	-	-	0.1

Intersection

Int Delay, s/veh 0.3

Movement	EBL	EBT	WBT	WBR	SBL	SBR
Lane Configurations						
Traffic Vol, veh/h	9	379	78	56	4	3
Future Vol, veh/h	9	379	78	56	4	3
Conflicting Peds, #/hr	0	0	0	0	0	0
Sign Control	Free	Free	Free	Free	Stop	Stop
RT Channelized	-	None	-	None	-	None
Storage Length	125	-	-	-	0	-
Veh in Median Storage, #	-	0	0	-	0	-
Grade, %	-	-1	1	-	0	-
Peak Hour Factor	90	90	90	90	90	90
Heavy Vehicles, %	0	0	0	0	0	0
Mvmt Flow	10	421	87	62	4	3

Major/Minor

	Major1	Major2	Minor2		
Conflicting Flow All	149	0	0	559	118
Stage 1	-	-	-	118	-
Stage 2	-	-	-	441	-
Critical Hdwy	4.1	-	-	6.4	6.2
Critical Hdwy Stg 1	-	-	-	5.4	-
Critical Hdwy Stg 2	-	-	-	5.4	-
Follow-up Hdwy	2.2	-	-	3.5	3.3
Pot Cap-1 Maneuver	1445	-	-	494	939
Stage 1	-	-	-	912	-
Stage 2	-	-	-	653	-
Platoon blocked, %	-	-	-	-	-
Mov Cap-1 Maneuver	1445	-	-	491	939
Mov Cap-2 Maneuver	-	-	-	491	-
Stage 1	-	-	-	906	-
Stage 2	-	-	-	653	-

Approach

	EB	WB	SB
HCM Control Delay, s	0.2	0	10.9
HCM LOS			B

Minor Lane/Major Mvmt

	EBL	EBT	WBT	WBR	SBLn1
Capacity (veh/h)	1445	-	-	-	617
HCM Lane V/C Ratio	0.007	-	-	-	0.013
HCM Control Delay (s)	7.5	-	-	-	10.9
HCM Lane LOS	A	-	-	-	B
HCM 95th %tile Q(veh)	0	-	-	-	0

Intersection						
Int Delay, s/veh	2					
Movement	EBL	EBT	WBT	WBR	SBL	SBR
Lane Configurations						
Traffic Vol, veh/h	133	382	51	30	6	9
Future Vol, veh/h	133	382	51	30	6	9
Conflicting Peds, #/hr	0	0	0	0	0	0
Sign Control	Free	Free	Free	Free	Stop	Stop
RT Channelized	-	None	-	None	-	None
Storage Length	125	-	-	-	0	-
Veh in Median Storage, #	-	0	0	-	0	-
Grade, %	-	-1	1	-	-1	-
Peak Hour Factor	83	83	83	83	83	83
Heavy Vehicles, %	1	1	0	5	0	11
Mvmt Flow	160	460	61	36	7	11

Major/Minor	Major1	Major2	Minor2		
Conflicting Flow All	97	0	-	0	859 79
Stage 1	-	-	-	-	79 -
Stage 2	-	-	-	-	780 -
Critical Hdwy	4.11	-	-	-	6.2 6.21
Critical Hdwy Stg 1	-	-	-	-	5.2 -
Critical Hdwy Stg 2	-	-	-	-	5.2 -
Follow-up Hdwy	2.209	-	-	-	3.5 3.399
Pot Cap-1 Maneuver	1503	-	-	-	346 959
Stage 1	-	-	-	-	953 -
Stage 2	-	-	-	-	476 -
Platoon blocked, %		-	-	-	
Mov Cap-1 Maneuver	1503	-	-	-	309 959
Mov Cap-2 Maneuver	-	-	-	-	309 -
Stage 1	-	-	-	-	852 -
Stage 2	-	-	-	-	476 -

Approach	EB	WB	SB
HCM Control Delay, s	2	0	12.2
HCM LOS			B

Minor Lane/Major Mvmt	EBL	EBT	WBT	WBR	SBLn1
Capacity (veh/h)	1503	-	-	-	521
HCM Lane V/C Ratio	0.107	-	-	-	0.035
HCM Control Delay (s)	7.7	-	-	-	12.2
HCM Lane LOS	A	-	-	-	B
HCM 95th %tile Q(veh)	0.4	-	-	-	0.1

Intersection

Int Delay, s/veh 2.9

Movement	EBT	EBR	WBL	WBT	NBL	NBR
Lane Configurations	↑	↗		↖↑	↖	↗
Traffic Vol, veh/h	13	62	1	69	65	2
Future Vol, veh/h	13	62	1	69	65	2
Conflicting Peds, #/hr	0	0	0	0	0	0
Sign Control	Free	Free	Free	Free	Stop	Stop
RT Channelized	-	None	-	None	-	None
Storage Length	-	0	-	-	140	0
Veh in Median Storage, #	0	-	-	0	0	-
Grade, %	-2	-	-	1	0	-
Peak Hour Factor	82	82	82	82	82	82
Heavy Vehicles, %	17	2	2	3	0	0
Mvmt Flow	16	76	1	84	79	2

Major/Minor	Major1	Major2	Minor1	Minor2	Minor3
Conflicting Flow All	0	0	92	0	60
Stage 1	-	-	-	-	16
Stage 2	-	-	-	-	44
Critical Hdwy	-	-	4.13	-	6.6
Critical Hdwy Stg 1	-	-	-	-	5.4
Critical Hdwy Stg 2	-	-	-	-	5.8
Follow-up Hdwy	-	-	2.219	-	3.5
Pot Cap-1 Maneuver	-	-	1502	-	949
Stage 1	-	-	-	-	1012
Stage 2	-	-	-	-	979
Platoon blocked, %	-	-	-	-	-
Mov Cap-1 Maneuver	-	-	1502	-	948
Mov Cap-2 Maneuver	-	-	-	-	948
Stage 1	-	-	-	-	1012
Stage 2	-	-	-	-	978

Approach	EB	WB	NB
HCM Control Delay, s	0	0.1	9.1
HCM LOS			A

Minor Lane/Major Mvmt	NBLn1	NBLn2	EBT	EBR	WBL	WBT
Capacity (veh/h)	948	1069	-	-	1502	-
HCM Lane V/C Ratio	0.084	0.002	-	-	0.001	-
HCM Control Delay (s)	9.1	8.4	-	-	7.4	0
HCM Lane LOS	A	A	-	-	A	A
HCM 95th %tile Q(veh)	0.3	0	-	-	0	-



Lane Group	EBL	EBT	WBT	WBR	SBL	SBR
Lane Configurations						
Traffic Volume (vph)	241	337	591	1026	132	24
Future Volume (vph)	241	337	591	1026	132	24
Ideal Flow (vphpl)	1900	1900	1900	1900	1900	1900
Grade (%)		0%	-1%		0%	
Storage Length (ft)	220			0	125	125
Storage Lanes	1			1	2	0
Taper Length (ft)	25				25	
Satd. Flow (prot)	1787	1863	3592	1607	3502	1615
Flt Permitted	0.381				0.950	
Satd. Flow (perm)	717	1863	3592	1607	3502	1615
Right Turn on Red				Yes		Yes
Satd. Flow (RTOR)				805		25
Link Speed (mph)		25	25		25	
Link Distance (ft)		608	1114		279	
Travel Time (s)		16.6	30.4		7.6	
Peak Hour Factor	0.96	0.96	0.96	0.96	0.96	0.96
Heavy Vehicles (%)	1%	2%	1%	1%	0%	0%
Shared Lane Traffic (%)						
Lane Group Flow (vph)	251	351	616	1069	138	25
Turn Type	pm+pt	NA	NA	Free	Perm	Perm
Protected Phases	5	2	6			
Permitted Phases	2			Free	4	4
Total Split (s)	15.0	66.0	51.0		34.0	34.0
Total Lost Time (s)	3.0	6.0	6.0		6.0	6.0
Act Effct Green (s)	63.0	60.0	48.0	82.2	10.2	10.2
Actuated g/C Ratio	0.77	0.73	0.58	1.00	0.12	0.12
v/c Ratio	0.38	0.26	0.29	0.67	0.32	0.11
Control Delay	4.3	4.3	9.3	2.2	35.0	14.3
Queue Delay	0.0	0.0	0.0	0.0	0.0	0.0
Total Delay	4.3	4.3	9.3	2.2	35.0	14.3
LOS	A	A	A	A	D	B
Approach Delay		4.3	4.8		31.8	
Approach LOS		A	A		C	
Queue Length 50th (ft)	26	48	75	0	34	0
Queue Length 95th (ft)	47	80	115	0	60	22
Internal Link Dist (ft)		528	1034		199	
Turn Bay Length (ft)	220				125	125
Base Capacity (vph)	705	1360	2099	1607	1192	566
Starvation Cap Reductn	0	0	0	0	0	0
Spillback Cap Reductn	0	0	0	0	0	0
Storage Cap Reductn	0	0	0	0	0	0
Reduced v/c Ratio	0.36	0.26	0.29	0.67	0.12	0.04

Intersection Summary

Area Type: Other
 Cycle Length: 100
 Actuated Cycle Length: 82.2
 Control Type: Semi Act-Uncoord

Maximum v/c Ratio: 0.67

Intersection Signal Delay: 6.5

Intersection LOS: A

Intersection Capacity Utilization 72.5%

ICU Level of Service C

Analysis Period (min) 15

Splits and Phases: 10: Meadow Road & Route 1 SB Ramps



Lane Group	EBL	EBT	EBR	WBL	WBT	WBR	NBL	NBT	NBR	SBL	SBT	SBR
Lane Configurations												
Traffic Volume (vph)	74	289	107	122	739	48	149	27	122	219	12	729
Future Volume (vph)	74	289	107	122	739	48	149	27	122	219	12	729
Ideal Flow (vphpl)	1900	1900	1900	1900	1900	1900	1900	1900	1900	1900	1900	1900
Lane Width (ft)	12	12	12	12	12	12	12	11	11	13	13	16
Grade (%)		-5%			3%			3%			2%	
Storage Length (ft)	115		0	325		450	0		0	120		0
Storage Lanes	1		0	1		1	1		0	1		1
Taper Length (ft)	25			25			25			25		
Satd. Flow (prot)	1850	3513	0	1760	3556	1591	1760	1574	0	1828	1944	1794
Flt Permitted	0.306			0.468			0.702					
Satd. Flow (perm)	596	3513	0	867	3556	1591	1301	1574	0	1924	1944	1794
Right Turn on Red			Yes			Yes			Yes			Yes
Satd. Flow (RTOR)		53				87		128				415
Link Speed (mph)		25			25			25				25
Link Distance (ft)		1114			553			434				429
Travel Time (s)		30.4			15.1			11.8				11.7
Peak Hour Factor	0.95	0.95	0.95	0.95	0.95	0.95	0.95	0.95	0.95	0.95	0.95	0.95
Heavy Vehicles (%)	0%	1%	1%	1%	0%	0%	1%	0%	1%	1%	0%	1%
Shared Lane Traffic (%)												
Lane Group Flow (vph)	78	417	0	128	778	51	157	156	0	231	13	767
Turn Type	pm+pt	NA		pm+pt	NA	Perm	pm+pt	NA		pm+pt	NA	Free
Protected Phases	5	2		1	6		3	8		7	4	
Permitted Phases	2			6		6	8			4		Free
Total Split (s)	15.0	59.0		15.0	59.0	59.0	16.0	36.0		16.0	36.0	
Total Lost Time (s)	3.0	6.0		3.0	6.0	6.0	3.0	7.0		3.0	7.0	
Act Effct Green (s)	63.5	53.1		66.5	56.2	56.2	30.3	10.9		16.4	10.8	104.6
Actuated g/C Ratio	0.61	0.51		0.64	0.54	0.54	0.29	0.10		0.16	0.10	1.00
v/c Ratio	0.17	0.23		0.20	0.41	0.06	0.32	0.56		0.80	0.06	0.43
Control Delay	8.0	13.2		8.0	15.9	1.0	30.9	20.3		61.9	43.4	0.7
Queue Delay	0.0	0.0		0.0	0.0	0.0	0.0	0.0		0.0	0.0	0.0
Total Delay	8.0	13.2		8.0	15.9	1.0	30.9	20.3		61.9	43.4	0.7
LOS	A	B		A	B	A	C	C		E	D	A
Approach Delay		12.4			14.1			25.6				15.3
Approach LOS		B			B			C				B
Queue Length 50th (ft)	17	66		29	157	0	81	17		~157	8	0
Queue Length 95th (ft)	38	108		57	229	7	140	81		199	27	0
Internal Link Dist (ft)		1034			473			354				349
Turn Bay Length (ft)	115			325		450				120		
Base Capacity (vph)	527	1808		664	1909	894	493	529		291	539	1794
Starvation Cap Reductn	0	0		0	0	0	0	0		0	0	0
Spillback Cap Reductn	0	0		0	0	0	0	0		0	0	0
Storage Cap Reductn	0	0		0	0	0	0	0		0	0	0
Reduced v/c Ratio	0.15	0.23		0.19	0.41	0.06	0.32	0.29		0.79	0.02	0.43
Intersection Summary												
Area Type:	Other											
Cycle Length:	126											
Actuated Cycle Length:	104.6											

Control Type: Semi Act-Uncoord

Maximum v/c Ratio: 0.80

Intersection Signal Delay: 15.5

Intersection LOS: B

Intersection Capacity Utilization 89.5%





ICU Level of Service E

Analysis Period (min) 15

~ Volume exceeds capacity, queue is theoretically infinite.

Queue shown is maximum after two cycles.

Splits and Phases: 20: Old Meadow Rd/Route 1 NB Ramps & Meadow Road

 Ø1	 Ø2	 Ø3	 Ø4
15 s	59 s	16 s	36 s
 Ø5	 Ø6	 Ø7	 Ø8
15 s	59 s	16 s	36 s



Lane Group	EBL	EBT	WBT	WBR	SBL	SBR
Lane Configurations	↶	↷	↶	↷	↶	↷
Traffic Volume (vph)	299	575	187	80	123	153
Future Volume (vph)	299	575	187	80	123	153
Ideal Flow (vphpl)	1900	1900	1900	1900	1900	1900
Lane Width (ft)	12	12	11	13	11	11
Grade (%)		1%	0%		0%	
Storage Length (ft)	190			155	265	0
Storage Lanes	1			1	1	1
Taper Length (ft)	25				25	
Satd. Flow (prot)	1778	1872	1801	1652	1745	1561
Flt Permitted	0.628				0.950	
Satd. Flow (perm)	1175	1872	1801	1652	1745	1561
Right Turn on Red				Yes		Yes
Satd. Flow (RTOR)						170
Link Speed (mph)		25	25		25	
Link Distance (ft)		2245	457		697	
Travel Time (s)		61.2	12.5		19.0	
Peak Hour Factor	0.90	0.90	0.90	0.90	0.90	0.90
Heavy Vehicles (%)	1%	1%	2%	1%	0%	0%
Shared Lane Traffic (%)						
Lane Group Flow (vph)	332	639	208	89	137	170
Turn Type	Perm	NA	NA	pm+ov	Prot	Prot
Protected Phases		2	6	4	4	8
Permitted Phases	2			6		
Total Split (s)	55.0	55.0	55.0	35.0	35.0	35.0
Total Lost Time (s)	5.0	5.0	5.0	5.0	5.0	5.0
Act Effct Green (s)	50.1	50.1	50.1	71.2	11.1	11.1
Actuated g/C Ratio	0.70	0.70	0.70	1.00	0.16	0.16
v/c Ratio	0.40	0.49	0.16	0.05	0.50	0.44
Control Delay	6.6	6.7	4.4	0.1	34.1	8.6
Queue Delay	0.0	0.0	0.0	0.0	0.0	0.0
Total Delay	6.6	6.7	4.4	0.1	34.1	8.6
LOS	A	A	A	A	C	A
Approach Delay		6.7	3.1		20.0	
Approach LOS		A	A		C	
Queue Length 50th (ft)	49	102	25	0	56	0
Queue Length 95th (ft)	111	202	55	0	106	47
Internal Link Dist (ft)		2165	377		617	
Turn Bay Length (ft)	190			155	265	
Base Capacity (vph)	826	1316	1266	1652	736	757
Starvation Cap Reductn	0	0	0	0	0	0
Spillback Cap Reductn	0	0	0	0	0	0
Storage Cap Reductn	0	0	0	0	0	0
Reduced v/c Ratio	0.40	0.49	0.16	0.05	0.19	0.22

Intersection Summary

Area Type: Other

Cycle Length: 90

Actuated Cycle Length: 71.2

Control Type: Semi Act-Uncoord

Maximum v/c Ratio: 0.50

Intersection Signal Delay: 8.6

Intersection LOS: A

Intersection Capacity Utilization 102.6%

ICU Level of Service G

Analysis Period (min) 15

Splits and Phases: 40: Meadow Road & Bear Brook Road

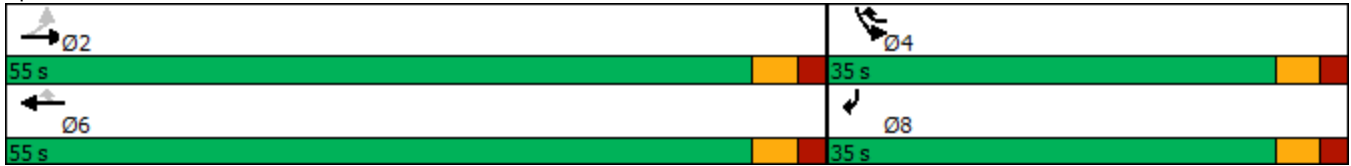

Intersection						
Int Delay, s/veh	3.3					
Movement	EBT	EBR	WBL	WBT	NBL	NBR
Lane Configurations	↑			↑		↑
Traffic Vol, veh/h	75	0	0	91	0	93
Future Vol, veh/h	75	0	0	91	0	93
Conflicting Peds, #/hr	0	0	0	0	0	0
Sign Control	Free	Free	Free	Free	Stop	Stop
RT Channelized	-	None	-	None	-	Yield
Storage Length	-	-	-	-	-	0
Veh in Median Storage, #	0	-	-	0	0	-
Grade, %	0	-	-	0	0	-
Peak Hour Factor	90	90	90	90	90	90
Heavy Vehicles, %	2	2	2	2	2	2
Mvmt Flow	83	0	0	101	0	103

Major/Minor	Major1	Major2	Minor1
Conflicting Flow All	0	-	-
Stage 1	-	-	-
Stage 2	-	-	-
Critical Hdwy	-	-	-
Critical Hdwy Stg 1	-	-	-
Critical Hdwy Stg 2	-	-	-
Follow-up Hdwy	-	-	-
Pot Cap-1 Maneuver	-	0	0
Stage 1	-	0	0
Stage 2	-	0	0
Platoon blocked, %	-	-	-
Mov Cap-1 Maneuver	-	-	-
Mov Cap-2 Maneuver	-	-	-
Stage 1	-	-	-
Stage 2	-	-	-

Approach	EB	WB	NB
HCM Control Delay, s	0	0	9.1
HCM LOS			A

Minor Lane/Major Mvmt	NBLn1	EBT	WBT
Capacity (veh/h)	976	-	-
HCM Lane V/C Ratio	0.106	-	-
HCM Control Delay (s)	9.1	-	-
HCM Lane LOS	A	-	-
HCM 95th %tile Q(veh)	0.4	-	-

Intersection

Int Delay, s/veh 29.7

Movement	EBL	EBT	WBT	WBR	SBL	SBR
Lane Configurations	↘	↑	↑	↗	↘	↗
Traffic Vol, veh/h	27	603	325	15	271	584
Future Vol, veh/h	27	603	325	15	271	584
Conflicting Peds, #/hr	0	0	0	0	0	0
Sign Control	Free	Free	Free	Free	Stop	Stop
RT Channelized	-	None	-	None	-	None
Storage Length	250	-	-	135	0	0
Veh in Median Storage, #	-	0	0	-	0	-
Grade, %	-	0	2	-	-1	-
Peak Hour Factor	94	94	94	94	94	94
Heavy Vehicles, %	0	1	0	0	0	0
Mvmt Flow	29	641	346	16	288	621

Major/Minor	Major1	Major2	Minor2
Conflicting Flow All	362	0	0 1045 346
Stage 1	-	-	- 346 -
Stage 2	-	-	- 699 -
Critical Hdwy	4.1	-	- 6.2 6.1
Critical Hdwy Stg 1	-	-	- 5.2 -
Critical Hdwy Stg 2	-	-	- 5.2 -
Follow-up Hdwy	2.2	-	- 3.5 3.3
Pot Cap-1 Maneuver	1208	-	- ~ 271 708
Stage 1	-	-	- 735 -
Stage 2	-	-	- 516 -
Platoon blocked, %	-	-	-
Mov Cap-1 Maneuver	1208	-	- ~ 264 708
Mov Cap-2 Maneuver	-	-	- ~ 264 -
Stage 1	-	-	- 717 -
Stage 2	-	-	- 516 -

Approach	EB	WB	SB
HCM Control Delay, s	0.3	0	63.2
HCM LOS			F

Minor Lane/Major Mvmt	EBL	EBT	WBT	WBR	SBLn1	SBLn2
Capacity (veh/h)	1208	-	-	-	264	708
HCM Lane V/C Ratio	0.024	-	-	-	1.092	0.878
HCM Control Delay (s)	8.1	-	-	-	123.8	35.1
HCM Lane LOS	A	-	-	-	F	E
HCM 95th %tile Q(veh)	0.1	-	-	-	12	10.8

Notes

~: Volume exceeds capacity \$: Delay exceeds 300s +: Computation Not Defined *: All major volume in platoon

Intersection						
Int Delay, s/veh	7.5					
Movement	EBL	EBR	NBL	NBT	SBT	SBR
Lane Configurations						
Traffic Vol, veh/h	46	246	14	28	609	23
Future Vol, veh/h	46	246	14	28	609	23
Conflicting Peds, #/hr	0	0	0	0	0	0
Sign Control	Stop	Stop	Free	Free	Free	Free
RT Channelized	-	None	-	None	-	None
Storage Length	100	0	0	-	-	-
Veh in Median Storage, #	0	-	-	0	0	-
Grade, %	1	-	-	-2	1	-
Peak Hour Factor	90	90	90	90	90	90
Heavy Vehicles, %	2	1	0	0	0	5
Mvmt Flow	51	273	16	31	677	26

Major/Minor	Minor2	Major1	Major2			
Conflicting Flow All	753	690	703	0	-	0
Stage 1	690	-	-	-	-	-
Stage 2	63	-	-	-	-	-
Critical Hdwy	6.62	6.31	4.1	-	-	-
Critical Hdwy Stg 1	5.62	-	-	-	-	-
Critical Hdwy Stg 2	5.62	-	-	-	-	-
Follow-up Hdwy	3.518	3.309	2.2	-	-	-
Pot Cap-1 Maneuver	362	438	904	-	-	-
Stage 1	479	-	-	-	-	-
Stage 2	956	-	-	-	-	-
Platoon blocked, %				-	-	-
Mov Cap-1 Maneuver	355	438	904	-	-	-
Mov Cap-2 Maneuver	355	-	-	-	-	-
Stage 1	470	-	-	-	-	-
Stage 2	956	-	-	-	-	-

Approach	EB	NB	SB
HCM Control Delay, s	24.5	3	0
HCM LOS	C		

Minor Lane/Major Mvmt	NBL	NBT	EBLn1	EBLn2	SBT	SBR
Capacity (veh/h)	904	-	355	438	-	-
HCM Lane V/C Ratio	0.017	-	0.144	0.624	-	-
HCM Control Delay (s)	9.1	-	16.8	25.9	-	-
HCM Lane LOS	A	-	C	D	-	-
HCM 95th %tile Q(veh)	0.1	-	0.5	4.1	-	-

Intersection

Int Delay, s/veh 1.7

Movement	EBL	EBT	WBT	WBR	SBL	SBR
Lane Configurations						
Traffic Vol, veh/h	11	237	42	10	35	16
Future Vol, veh/h	11	237	42	10	35	16
Conflicting Peds, #/hr	0	0	0	0	0	0
Sign Control	Free	Free	Free	Free	Stop	Stop
RT Channelized	-	None	-	None	-	None
Storage Length	125	-	-	-	0	-
Veh in Median Storage, #	-	0	0	-	0	-
Grade, %	-	-1	1	-	0	-
Peak Hour Factor	90	90	90	90	90	90
Heavy Vehicles, %	9	2	0	10	3	0
Mvmt Flow	12	263	47	11	39	18

Major/Minor	Major1	Major2	Minor2
Conflicting Flow All	58	0	0 340 53
Stage 1	-	-	- 53 -
Stage 2	-	-	- 287 -
Critical Hdwy	4.19	-	- 6.43 6.2
Critical Hdwy Stg 1	-	-	- 5.43 -
Critical Hdwy Stg 2	-	-	- 5.43 -
Follow-up Hdwy	2.281	-	- 3.527 3.3
Pot Cap-1 Maneuver	1503	-	- 654 1020
Stage 1	-	-	- 967 -
Stage 2	-	-	- 759 -
Platoon blocked, %		-	- -
Mov Cap-1 Maneuver	1503	-	- 649 1020
Mov Cap-2 Maneuver	-	-	- 649 -
Stage 1	-	-	- 959 -
Stage 2	-	-	- 759 -

Approach	EB	WB	SB
HCM Control Delay, s	0.3	0	10.3
HCM LOS			B

Minor Lane/Major Mvmt	EBL	EBT	WBT	WBR	SBLn1
Capacity (veh/h)	1503	-	-	-	733
HCM Lane V/C Ratio	0.008	-	-	-	0.077
HCM Control Delay (s)	7.4	-	-	-	10.3
HCM Lane LOS	A	-	-	-	B
HCM 95th %tile Q(veh)	0	-	-	-	0.3

Intersection

Int Delay, s/veh 0.7

Movement	EBL	EBT	WBT	WBR	SBL	SBR
Lane Configurations						
Traffic Vol, veh/h	2	232	44	12	18	1
Future Vol, veh/h	2	232	44	12	18	1
Conflicting Peds, #/hr	0	0	0	0	0	0
Sign Control	Free	Free	Free	Free	Stop	Stop
RT Channelized	-	None	-	None	-	None
Storage Length	125	-	-	-	0	-
Veh in Median Storage, #	-	0	0	-	0	-
Grade, %	-	-1	1	-	0	-
Peak Hour Factor	90	90	90	90	90	90
Heavy Vehicles, %	0	0	0	0	0	0
Mvmt Flow	2	258	49	13	20	1

Major/Minor	Major1	Major2	Minor2		
Conflicting Flow All	62	0	-	0	318 56
Stage 1	-	-	-	-	56 -
Stage 2	-	-	-	-	262 -
Critical Hdwy	4.1	-	-	-	6.4 6.2
Critical Hdwy Stg 1	-	-	-	-	5.4 -
Critical Hdwy Stg 2	-	-	-	-	5.4 -
Follow-up Hdwy	2.2	-	-	-	3.5 3.3
Pot Cap-1 Maneuver	1554	-	-	-	679 1016
Stage 1	-	-	-	-	972 -
Stage 2	-	-	-	-	786 -
Platoon blocked, %		-	-	-	
Mov Cap-1 Maneuver	1554	-	-	-	678 1016
Mov Cap-2 Maneuver	-	-	-	-	678 -
Stage 1	-	-	-	-	971 -
Stage 2	-	-	-	-	786 -

Approach	EB	WB	SB
HCM Control Delay, s	0.1	0	10.4
HCM LOS			B

Minor Lane/Major Mvmt	EBL	EBT	WBT	WBR	SBLn1
Capacity (veh/h)	1554	-	-	-	690
HCM Lane V/C Ratio	0.001	-	-	-	0.031
HCM Control Delay (s)	7.3	-	-	-	10.4
HCM Lane LOS	A	-	-	-	B
HCM 95th %tile Q(veh)	0	-	-	-	0.1

Intersection

Int Delay, s/veh	4					
Movement	EBL	EBT	WBT	WBR	SBL	SBR
Lane Configurations	↘	↑	↗		↘	
Traffic Vol, veh/h	8	157	42	4	76	51
Future Vol, veh/h	8	157	42	4	76	51
Conflicting Peds, #/hr	0	0	0	0	0	0
Sign Control	Free	Free	Free	Free	Stop	Stop
RT Channelized	-	None	-	None	-	None
Storage Length	125	-	-	-	0	-
Veh in Median Storage, #	-	0	0	-	0	-
Grade, %	-	-1	1	-	-1	-
Peak Hour Factor	90	90	90	90	90	90
Heavy Vehicles, %	13	2	0	0	0	2
Mvmt Flow	9	174	47	4	84	57

Major/Minor	Major1	Major2	Minor2		
Conflicting Flow All	51	0	-	0	241 49
Stage 1	-	-	-	-	49 -
Stage 2	-	-	-	-	192 -
Critical Hdwy	4.23	-	-	-	6.2 6.12
Critical Hdwy Stg 1	-	-	-	-	5.2 -
Critical Hdwy Stg 2	-	-	-	-	5.2 -
Follow-up Hdwy	2.317	-	-	-	3.5 3.318
Pot Cap-1 Maneuver	1488	-	-	-	762 1021
Stage 1	-	-	-	-	981 -
Stage 2	-	-	-	-	854 -
Platoon blocked, %		-	-	-	
Mov Cap-1 Maneuver	1488	-	-	-	757 1021
Mov Cap-2 Maneuver	-	-	-	-	757 -
Stage 1	-	-	-	-	975 -
Stage 2	-	-	-	-	854 -

Approach	EB	WB	SB
HCM Control Delay, s	0.4	0	10.1
HCM LOS			B

Minor Lane/Major Mvmt	EBL	EBT	WBT	WBR	SBLn1
Capacity (veh/h)	1488	-	-	-	845
HCM Lane V/C Ratio	0.006	-	-	-	0.167
HCM Control Delay (s)	7.4	-	-	-	10.1
HCM Lane LOS	A	-	-	-	B
HCM 95th %tile Q(veh)	0	-	-	-	0.6

Intersection

Int Delay, s/veh 5

Movement	EBT	EBR	WBL	WBT	NBL	NBR
Lane Configurations	↑	↗		↖↑	↖	↗
Traffic Vol, veh/h	47	194	3	45	253	14
Future Vol, veh/h	47	194	3	45	253	14
Conflicting Peds, #/hr	0	0	0	0	0	0
Sign Control	Free	Free	Free	Free	Stop	Stop
RT Channelized	-	None	-	None	-	None
Storage Length	-	0	-	-	140	0
Veh in Median Storage, #	0	-	-	0	0	-
Grade, %	-2	-	-	1	0	-
Peak Hour Factor	94	94	94	94	94	94
Heavy Vehicles, %	2	0	0	3	0	0
Mvmt Flow	50	206	3	48	269	15

Major/Minor	Major1	Major2	Minor1
Conflicting Flow All	0	0	256
Stage 1	-	-	-
Stage 2	-	-	-
Critical Hdwy	-	-	4.1
Critical Hdwy Stg 1	-	-	-
Critical Hdwy Stg 2	-	-	-
Follow-up Hdwy	-	-	2.2
Pot Cap-1 Maneuver	-	-	1321
Stage 1	-	-	-
Stage 2	-	-	-
Platoon blocked, %	-	-	-
Mov Cap-1 Maneuver	-	-	1321
Mov Cap-2 Maneuver	-	-	-
Stage 1	-	-	-
Stage 2	-	-	-

Approach	EB	WB	NB
HCM Control Delay, s	0	0.5	10.4
HCM LOS			B

Minor Lane/Major Mvmt	NBLn1	NBLn2	EBT	EBR	WBL	WBT
Capacity (veh/h)	921	1024	-	-	1321	-
HCM Lane V/C Ratio	0.292	0.015	-	-	0.002	-
HCM Control Delay (s)	10.5	8.6	-	-	7.7	0
HCM Lane LOS	B	A	-	-	A	A
HCM 95th %tile Q(veh)	1.2	0	-	-	0	-



Lane Group	EBL	EBT	WBT	WBR	SBL	SBR
Lane Configurations						
Traffic Volume (vph)	56	167	654	548	144	11
Future Volume (vph)	56	167	654	548	144	11
Ideal Flow (vphpl)	1900	1900	1900	1900	1900	1900
Grade (%)		0%	-1%		0%	
Storage Length (ft)	220			0	125	125
Storage Lanes	1			1	2	0
Taper Length (ft)	25				25	
Satd. Flow (prot)	1656	1792	3592	1576	3367	1553
Flt Permitted	0.360				0.950	
Satd. Flow (perm)	628	1792	3592	1576	3367	1553
Right Turn on Red				Yes		Yes
Satd. Flow (RTOR)				571		11
Link Speed (mph)		25	25		25	
Link Distance (ft)		608	1114		279	
Travel Time (s)		16.6	30.4		7.6	
Peak Hour Factor	0.96	0.96	0.96	0.96	0.96	0.96
Heavy Vehicles (%)	9%	6%	1%	3%	4%	4%
Shared Lane Traffic (%)						
Lane Group Flow (vph)	58	174	681	571	150	11
Turn Type	pm+pt	NA	NA	Free	Perm	Perm
Protected Phases	5	2	6			
Permitted Phases	2			Free	4	4
Total Split (s)	15.0	66.0	51.0		34.0	34.0
Total Lost Time (s)	3.0	6.0	6.0		6.0	6.0
Act Effct Green (s)	63.0	60.0	52.3	82.4	10.4	10.4
Actuated g/C Ratio	0.76	0.73	0.63	1.00	0.13	0.13
v/c Ratio	0.10	0.13	0.30	0.36	0.35	0.05
Control Delay	2.9	3.7	7.7	0.6	35.5	17.8
Queue Delay	0.0	0.0	0.0	0.0	0.0	0.0
Total Delay	2.9	3.7	7.7	0.6	35.5	17.8
LOS	A	A	A	A	D	B
Approach Delay		3.5	4.5		34.3	
Approach LOS		A	A		C	
Queue Length 50th (ft)	5	22	77	0	37	0
Queue Length 95th (ft)	14	41	116	0	64	15
Internal Link Dist (ft)		528	1034		199	
Turn Bay Length (ft)	220				125	125
Base Capacity (vph)	629	1305	2280	1576	1144	535
Starvation Cap Reductn	0	0	0	0	0	0
Spillback Cap Reductn	0	0	0	0	0	0
Storage Cap Reductn	0	0	0	0	0	0
Reduced v/c Ratio	0.09	0.13	0.30	0.36	0.13	0.02

Intersection Summary

Area Type: Other
 Cycle Length: 100
 Actuated Cycle Length: 82.4
 Control Type: Semi Act-Uncoord

Maximum v/c Ratio: 0.36

Intersection Signal Delay: 7.3

Intersection LOS: A























Intersection Capacity Utilization 63.3%

ICU Level of Service B

Analysis Period (min) 15

Splits and Phases: 10: Meadow Road & Route 1 SB Ramps



												
Lane Group	EBL	EBT	EBR	WBL	WBT	WBR	NBL	NBT	NBR	SBL	SBT	SBR
Lane Configurations												
Traffic Volume (vph)	43	223	45	36	501	136	72	38	58	119	6	629
Future Volume (vph)	43	223	45	36	501	136	72	38	58	119	6	629
Ideal Flow (vphpl)	1900	1900	1900	1900	1900	1900	1900	1900	1900	1900	1900	1900
Lane Width (ft)	12	12	12	12	12	12	12	11	11	13	13	16
Grade (%)		-5%			3%			3%			2%	
Storage Length (ft)	115		0	325		450	0		0	120		0
Storage Lanes	1		0	1		1	1		0	1		1
Taper Length (ft)	25			25			25			25		
Satd. Flow (prot)	1814	3458	0	1726	3521	1560	1710	1566	0	1775	1944	1794
Flt Permitted	0.433			0.579			0.494			0.784		
Satd. Flow (perm)	827	3458	0	1052	3521	1560	889	1566	0	1465	1944	1794
Right Turn on Red			Yes			Yes			Yes			Yes
Satd. Flow (RTOR)		23				143		57				556
Link Speed (mph)		25			25			25				25
Link Distance (ft)		1114			682			434				429
Travel Time (s)		30.4			18.6			11.8				11.7
Peak Hour Factor	0.95	0.95	0.95	0.95	0.95	0.95	0.95	0.95	0.95	0.95	0.95	0.95
Heavy Vehicles (%)	2%	4%	6%	3%	1%	2%	4%	5%	5%	4%	0%	1%
Shared Lane Traffic (%)												
Lane Group Flow (vph)	45	282	0	38	527	143	76	101	0	125	6	662
Turn Type	pm+pt	NA		pm+pt	NA	Perm	pm+pt	NA		pm+pt	NA	Free
Protected Phases	5	2		1	6		3	8		7	4	
Permitted Phases	2			6		6	8			4		Free
Total Split (s)	15.0	59.0		15.0	59.0	59.0	16.0	36.0		16.0	36.0	
Total Lost Time (s)	3.0	6.0		3.0	6.0	6.0	3.0	7.0		3.0	7.0	
Act Effct Green (s)	60.9	53.9		60.7	53.8	53.8	24.0	10.9		16.2	11.0	95.2
Actuated g/C Ratio	0.64	0.57		0.64	0.57	0.57	0.25	0.11		0.17	0.12	1.00
v/c Ratio	0.08	0.14		0.05	0.26	0.15	0.19	0.44		0.43	0.03	0.37
Control Delay	7.3	11.0		7.2	12.9	2.8	27.4	28.1		40.6	41.2	0.6
Queue Delay	0.0	0.0		0.0	0.0	0.0	0.0	0.0		0.0	0.0	0.0
Total Delay	7.3	11.0		7.2	12.9	2.8	27.4	28.1		40.6	41.2	0.6
LOS	A	B		A	B	A	C	C		D	D	A
Approach Delay		10.5			10.5			27.8				7.2
Approach LOS		B			B			C				A
Queue Length 50th (ft)	10	43		8	95	0	36	27		77	4	0
Queue Length 95th (ft)	24	72		21	143	31	73	79		110	16	0
Internal Link Dist (ft)		1034			602			354				349
Turn Bay Length (ft)	115			325		450				120		
Base Capacity (vph)	669	1966		776	1989	943	437	523		301	600	1794
Starvation Cap Reductn	0	0		0	0	0	0	0		0	0	0
Spillback Cap Reductn	0	0		0	0	0	0	0		0	0	0
Storage Cap Reductn	0	0		0	0	0	0	0		0	0	0
Reduced v/c Ratio	0.07	0.14		0.05	0.26	0.15	0.17	0.19		0.42	0.01	0.37

Intersection Summary

Area Type: Other

Cycle Length: 126

Actuated Cycle Length: 95.2

Control Type: Semi Act-Uncoord

Maximum v/c Ratio: 0.44

Intersection Signal Delay: 10.7







Intersection LOS: B

Intersection Capacity Utilization 70.8%

ICU Level of Service C

Analysis Period (min) 15

Splits and Phases: 20: Old Meadow Rd/Route 1 NB Ramps & Meadow Road

 Ø1	 Ø2	 Ø3	 Ø4
15 s	59 s	16 s	36 s
 Ø5	 Ø6	 Ø7	 Ø8
15 s	59 s	16 s	36 s

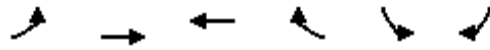

Lane Group	EBL	EBT	WBT	WBR	SBL	SBR
Lane Configurations						
Traffic Volume (vph)	125	135	457	80	50	273
Future Volume (vph)	125	135	457	80	50	273
Ideal Flow (vphpl)	1900	1900	1900	1900	1900	1900
Lane Width (ft)	12	12	11	13	11	11
Grade (%)		1%	0%		0%	
Storage Length (ft)	190			155	265	0
Storage Lanes	1			1	1	1
Taper Length (ft)	25				25	
Satd. Flow (prot)	1727	1750	1818	1560	1517	1531
Flt Permitted	0.464				0.950	
Satd. Flow (perm)	843	1750	1818	1560	1517	1531
Right Turn on Red				Yes		Yes
Satd. Flow (RTOR)						294
Link Speed (mph)		25	25		25	
Link Distance (ft)		2245	457		697	
Travel Time (s)		61.2	12.5		19.0	
Peak Hour Factor	0.93	0.93	0.93	0.93	0.93	0.93
Heavy Vehicles (%)	4%	8%	1%	7%	15%	2%
Shared Lane Traffic (%)						
Lane Group Flow (vph)	134	145	491	86	54	294
Turn Type	Perm	NA	NA	pm+ov	Prot	Prot
Protected Phases		2	6	4	4	8
Permitted Phases	2			6		
Total Split (s)	55.0	55.0	55.0	35.0	35.0	35.0
Total Lost Time (s)	5.0	5.0	5.0	5.0	5.0	5.0
Act Effct Green (s)	50.1	50.1	50.1	69.0	8.9	8.9
Actuated g/C Ratio	0.73	0.73	0.73	1.00	0.13	0.13
v/c Ratio	0.22	0.11	0.37	0.06	0.28	0.65
Control Delay	4.6	3.5	4.9	0.1	30.5	11.2
Queue Delay	0.0	0.0	0.0	0.0	0.0	0.0
Total Delay	4.6	3.5	4.9	0.1	30.5	11.2
LOS	A	A	A	A	C	B
Approach Delay		4.0	4.1		14.2	
Approach LOS		A	A		B	
Queue Length 50th (ft)	13	13	56	0	21	0
Queue Length 95th (ft)	41	37	131	0	51	62
Internal Link Dist (ft)		2165	377		617	
Turn Bay Length (ft)	190			155	265	
Base Capacity (vph)	611	1269	1319	1560	660	832
Starvation Cap Reductn	0	0	0	0	0	0
Spillback Cap Reductn	0	0	0	0	0	0
Storage Cap Reductn	0	0	0	0	0	0
Reduced v/c Ratio	0.22	0.11	0.37	0.06	0.08	0.35

Intersection Summary

Area Type: Other

Cycle Length: 90

Actuated Cycle Length: 69

Control Type: Semi Act-Uncoord

Maximum v/c Ratio: 0.65

Intersection Signal Delay: 7.0

Intersection LOS: A

Intersection Capacity Utilization 101.7%

ICU Level of Service G

Analysis Period (min) 15

Splits and Phases: 40: Meadow Road & Bear Brook Road

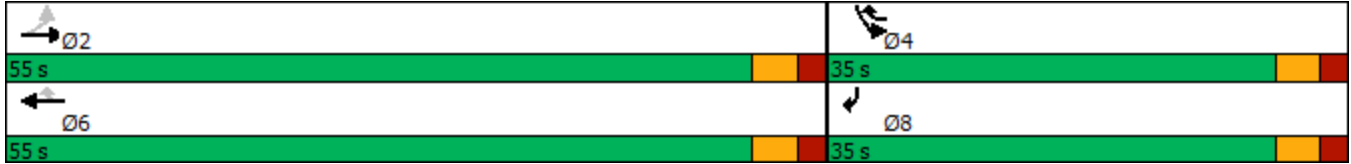

Intersection						
Int Delay, s/veh	9.8					
Movement	EBT	EBR	WBL	WBT	NBL	NBR
Lane Configurations	↑			↑		↑
Traffic Vol, veh/h	70	0	0	71	0	469
Future Vol, veh/h	70	0	0	71	0	469
Conflicting Peds, #/hr	0	0	0	0	0	0
Sign Control	Free	Free	Free	Free	Stop	Stop
RT Channelized	-	None	-	None	-	Yield
Storage Length	-	-	-	-	-	0
Veh in Median Storage, #	0	-	-	0	0	-
Grade, %	0	-	-	0	0	-
Peak Hour Factor	90	90	90	90	90	90
Heavy Vehicles, %	2	2	2	2	2	2
Mvmt Flow	78	0	0	79	0	521

Major/Minor	Major1	Major2	Minor1	Minor2
Conflicting Flow All	0	-	-	78
Stage 1	-	-	-	-
Stage 2	-	-	-	-
Critical Hdwy	-	-	-	6.22
Critical Hdwy Stg 1	-	-	-	-
Critical Hdwy Stg 2	-	-	-	-
Follow-up Hdwy	-	-	-	3.318
Pot Cap-1 Maneuver	-	0	0	983
Stage 1	-	0	0	-
Stage 2	-	0	0	-
Platoon blocked, %	-	-	-	-
Mov Cap-1 Maneuver	-	-	-	983
Mov Cap-2 Maneuver	-	-	-	-
Stage 1	-	-	-	-
Stage 2	-	-	-	-

Approach	EB	WB	NB
HCM Control Delay, s	0	0	12.7
HCM LOS			B

Minor Lane/Major Mvmt	NBLn1	EBT	WBT
Capacity (veh/h)	983	-	-
HCM Lane V/C Ratio	0.53	-	-
HCM Control Delay (s)	12.7	-	-
HCM Lane LOS	B	-	-
HCM 95th %tile Q(veh)	3.2	-	-

Intersection								
Intersection Delay, s/veh	5.7							
Intersection LOS	A							
Approach	EB		WB		NB		SB	
Entry Lanes	2		2		1		2	
Conflicting Circle Lanes	1		1		1		1	
Adj Approach Flow, veh/h	365		777		49		68	
Demand Flow Rate, veh/h	380		782		49		68	
Vehicles Circulating, veh/h	26		146		389		558	
Vehicles Exiting, veh/h	600		292		17		370	
Ped Vol Crossing Leg, #/h	0		0		0		0	
Ped Cap Adj	1.000		1.000		1.000		1.000	
Approach Delay, s/veh	4.9		6.3		4.4		4.6	
Approach LOS	A		A		A		A	
Lane	Left	Right	Left	Right	Left	Left	Right	
Designated Moves	LT	R	LT	R	LTR	LT	R	
Assumed Moves	LT	R	LT	R	LTR	LT	R	
RT Channelized								
Lane Util	0.963	0.037	0.668	0.332	1.000	0.338	0.662	
Follow-Up Headway, s	2.535	2.535	2.535	2.535	2.609	2.535	2.535	
Critical Headway, s	4.544	4.544	4.544	4.544	4.976	4.544	4.544	
Entry Flow, veh/h	366	14	522	260	49	23	45	
Cap Entry Lane, veh/h	1387	1387	1243	1243	928	855	855	
Entry HV Adj Factor	0.960	1.000	0.990	1.000	1.000	1.000	1.000	
Flow Entry, veh/h	351	14	517	260	49	23	45	
Cap Entry, veh/h	1331	1387	1231	1243	928	855	855	
V/C Ratio	0.264	0.010	0.420	0.209	0.053	0.027	0.053	
Control Delay, s/veh	5.0	2.7	7.1	4.7	4.4	4.5	4.7	
LOS	A	A	A	A	A	A	A	
95th %tile Queue, veh	1	0	2	1	0	0	0	

Intersection

Int Delay, s/veh	15.3					
Movement	EBL	EBR	NBL	NBT	SBT	SBR
Lane Configurations	↙	↗	↙	↑	↗	
Traffic Vol, veh/h	289	27	139	209	37	30
Future Vol, veh/h	289	27	139	209	37	30
Conflicting Peds, #/hr	0	0	0	0	0	0
Sign Control	Stop	Stop	Free	Free	Free	Free
RT Channelized	-	None	-	None	-	None
Storage Length	100	0	0	-	-	-
Veh in Median Storage, #	0	-	-	0	0	-
Grade, %	1	-	-	-2	1	-
Peak Hour Factor	93	93	93	93	93	93
Heavy Vehicles, %	0	0	0	0	0	0
Mvmt Flow	311	29	149	225	40	32

Major/Minor	Minor2	Major1		Major2	
Conflicting Flow All	579	56	72	0	0
Stage 1	56	-	-	-	-
Stage 2	523	-	-	-	-
Critical Hdwy	6.6	6.3	4.1	-	-
Critical Hdwy Stg 1	5.6	-	-	-	-
Critical Hdwy Stg 2	5.6	-	-	-	-
Follow-up Hdwy	3.5	3.3	2.2	-	-
Pot Cap-1 Maneuver	465	1015	1541	-	-
Stage 1	969	-	-	-	-
Stage 2	582	-	-	-	-
Platoon blocked, %				-	-
Mov Cap-1 Maneuver	420	1015	1541	-	-
Mov Cap-2 Maneuver	420	-	-	-	-
Stage 1	875	-	-	-	-
Stage 2	582	-	-	-	-

Approach	EB	NB	SB
HCM Control Delay, s	32.1	3	0
HCM LOS	D		

Minor Lane/Major Mvmt	NBL	NBT	EBLn1	EBLn2	SBT	SBR
Capacity (veh/h)	1541	-	420	1015	-	-
HCM Lane V/C Ratio	0.097	-	0.74	0.029	-	-
HCM Control Delay (s)	7.6	-	34.3	8.7	-	-
HCM Lane LOS	A	-	D	A	-	-
HCM 95th %tile Q(veh)	0.3	-	5.9	0.1	-	-

Intersection												
Int Delay, s/veh	0.9											
Movement	EBL	EBT	EBR	WBL	WBT	WBR	NBL	NBT	NBR	SBL	SBT	SBR
Lane Configurations												
Traffic Vol, veh/h	36	349	0	1	137	16	0	0	3	10	0	6
Future Vol, veh/h	36	349	0	1	137	16	0	0	3	10	0	6
Conflicting Peds, #/hr	0	0	0	0	0	0	0	0	0	0	0	0
Sign Control	Free	Free	Free	Free	Free	Free	Stop	Stop	Stop	Stop	Stop	Stop
RT Channelized	-	-	None	-	-	None	-	-	None	-	-	None
Storage Length	125	-	-	125	-	-	-	-	-	-	-	-
Veh in Median Storage, #	-	0	-	-	0	-	-	0	-	-	0	-
Grade, %	-	-1	-	-	1	-	-	-1	-	-	0	-
Peak Hour Factor	90	90	90	90	90	90	90	90	90	90	90	90
Heavy Vehicles, %	3	0	0	0	0	0	0	0	0	0	0	0
Mvmt Flow	40	388	0	1	152	18	0	0	3	11	0	7

Major/Minor	Major1			Major2			Minor1			Minor2		
Conflicting Flow All	170	0	0	388	0	0	635	640	388	633	631	161
Stage 1	-	-	-	-	-	-	468	468	-	163	163	-
Stage 2	-	-	-	-	-	-	167	172	-	470	468	-
Critical Hdwy	4.13	-	-	4.1	-	-	6.9	6.3	6.1	7.1	6.5	6.2
Critical Hdwy Stg 1	-	-	-	-	-	-	5.9	5.3	-	6.1	5.5	-
Critical Hdwy Stg 2	-	-	-	-	-	-	5.9	5.3	-	6.1	5.5	-
Follow-up Hdwy	2.227	-	-	2.2	-	-	3.5	4	3.3	3.5	4	3.3
Pot Cap-1 Maneuver	1401	-	-	1182	-	-	408	410	672	395	401	889
Stage 1	-	-	-	-	-	-	595	579	-	844	767	-
Stage 2	-	-	-	-	-	-	848	768	-	578	565	-
Platoon blocked, %		-	-		-	-						
Mov Cap-1 Maneuver	1401	-	-	1182	-	-	396	398	672	384	389	889
Mov Cap-2 Maneuver	-	-	-	-	-	-	396	398	-	384	389	-
Stage 1	-	-	-	-	-	-	578	562	-	820	766	-
Stage 2	-	-	-	-	-	-	841	767	-	559	549	-

Approach	EB			WB			NB			SB		
HCM Control Delay, s	0.7			0.1			10.4			12.7		
HCM LOS							B			B		

Minor Lane/Major Mvmt	NBLn1	EBL	EBT	EBR	WBL	WBT	WBR	SBLn1
Capacity (veh/h)	672	1401	-	-	1182	-	-	488
HCM Lane V/C Ratio	0.005	0.029	-	-	0.001	-	-	0.036
HCM Control Delay (s)	10.4	7.6	-	-	8	-	-	12.7
HCM Lane LOS		B	A	-	-	A	-	B
HCM 95th %tile Q(veh)		0	0.1	-	-	0	-	0.1

Intersection

Int Delay, s/veh 0.3

Movement	EBL	EBT	WBT	WBR	SBL	SBR
Lane Configurations						
Traffic Vol, veh/h	9	383	87	56	4	3
Future Vol, veh/h	9	383	87	56	4	3
Conflicting Peds, #/hr	0	0	0	0	0	0
Sign Control	Free	Free	Free	Free	Stop	Stop
RT Channelized	-	None	-	None	-	None
Storage Length	125	-	-	-	0	-
Veh in Median Storage, #	-	0	0	-	0	-
Grade, %	-	-1	1	-	0	-
Peak Hour Factor	90	90	90	90	90	90
Heavy Vehicles, %	0	0	0	0	0	0
Mvmt Flow	10	426	97	62	4	3

Major/Minor

	Major1	Major2	Minor2		
Conflicting Flow All	159	0	0	574	128
Stage 1	-	-	-	128	-
Stage 2	-	-	-	446	-
Critical Hdwy	4.1	-	-	6.4	6.2
Critical Hdwy Stg 1	-	-	-	5.4	-
Critical Hdwy Stg 2	-	-	-	5.4	-
Follow-up Hdwy	2.2	-	-	3.5	3.3
Pot Cap-1 Maneuver	1433	-	-	484	927
Stage 1	-	-	-	903	-
Stage 2	-	-	-	649	-
Platoon blocked, %	-	-	-	-	-
Mov Cap-1 Maneuver	1433	-	-	481	927
Mov Cap-2 Maneuver	-	-	-	481	-
Stage 1	-	-	-	897	-
Stage 2	-	-	-	649	-

Approach

	EB	WB	SB
HCM Control Delay, s	0.2	0	11
HCM LOS			B

Minor Lane/Major Mvmt

	EBL	EBT	WBT	WBR	SBLn1
Capacity (veh/h)	1433	-	-	-	606
HCM Lane V/C Ratio	0.007	-	-	-	0.013
HCM Control Delay (s)	7.5	-	-	-	11
HCM Lane LOS	A	-	-	-	B
HCM 95th %tile Q(veh)	0	-	-	-	0

Intersection

Int Delay, s/veh 2.2

Movement	EBL	EBT	EBR	WBL	WBT	WBR	NBL	NBT	NBR	SBL	SBT	SBR
Lane Configurations	↖	↗		↖	↗			↕			↕	
Traffic Vol, veh/h	133	382	25	5	55	30	7	0	4	6	0	9
Future Vol, veh/h	133	382	25	5	55	30	7	0	4	6	0	9
Conflicting Peds, #/hr	0	0	0	0	0	0	0	0	0	0	0	0
Sign Control	Free	Free	Free	Free	Free	Free	Stop	Stop	Stop	Stop	Stop	Stop
RT Channelized	-	-	None	-	-	None	-	-	None	-	-	None
Storage Length	125	-	-	125	-	-	-	-	-	-	-	-
Veh in Median Storage, #	-	0	-	-	0	-	-	0	-	-	0	-
Grade, %	-	-1	-	-	1	-	-	1	-	-	-1	-
Peak Hour Factor	83	83	83	83	83	83	83	83	83	83	83	83
Heavy Vehicles, %	1	1	2	2	0	5	2	2	2	0	0	11
Mvmt Flow	160	460	30	6	66	36	8	0	5	7	0	11

Major/Minor	Major1	Major2	Minor1	Minor2
Conflicting Flow All	102	0	0	490
Stage 1	-	-	-	-
Stage 2	-	-	-	-
Critical Hdwy	4.11	-	-	4.12
Critical Hdwy Stg 1	-	-	-	-
Critical Hdwy Stg 2	-	-	-	-
Follow-up Hdwy	2.209	-	-	2.218
Pot Cap-1 Maneuver	1496	-	-	1073
Stage 1	-	-	-	-
Stage 2	-	-	-	-
Platoon blocked, %	-	-	-	-
Mov Cap-1 Maneuver	1496	-	-	1073
Mov Cap-2 Maneuver	-	-	-	-
Stage 1	-	-	-	-
Stage 2	-	-	-	-

Approach	EB	WB	NB	SB
HCM Control Delay, s	1.9	0.5	18.1	13.3
HCM LOS			C	B

Minor Lane/Major Mvmt	NBLn1	EBL	EBT	EBR	WBL	WBT	WBR	SBLn1
Capacity (veh/h)	289	1496	-	-	1073	-	-	450
HCM Lane V/C Ratio	0.046	0.107	-	-	0.006	-	-	0.04
HCM Control Delay (s)	18.1	7.7	-	-	8.4	-	-	13.3
HCM Lane LOS	C	A	-	-	A	-	-	B
HCM 95th %tile Q(veh)	0.1	0.4	-	-	0	-	-	0.1

Intersection

Int Delay, s/veh 2.5

Movement	EBT	EBR	WBL	WBT	NBL	NBR
Lane Configurations	↑	↗		↖↑	↘	↗
Traffic Vol, veh/h	25	62	1	103	65	2
Future Vol, veh/h	25	62	1	103	65	2
Conflicting Peds, #/hr	0	0	0	0	0	0
Sign Control	Free	Free	Free	Free	Stop	Stop
RT Channelized	-	None	-	None	-	None
Storage Length	-	0	-	-	140	0
Veh in Median Storage, #	0	-	-	0	0	-
Grade, %	-2	-	-	1	0	-
Peak Hour Factor	82	82	82	82	82	82
Heavy Vehicles, %	17	2	2	3	0	0
Mvmt Flow	30	76	1	126	79	2

Major/Minor	Major1	Major2	Minor1	Minor2	Minor3
Conflicting Flow All	0	0	106	0	95
Stage 1	-	-	-	-	30
Stage 2	-	-	-	-	65
Critical Hdwy	-	-	4.13	-	6.6
Critical Hdwy Stg 1	-	-	-	-	5.4
Critical Hdwy Stg 2	-	-	-	-	5.8
Follow-up Hdwy	-	-	2.219	-	3.5
Pot Cap-1 Maneuver	-	-	1484	-	905
Stage 1	-	-	-	-	998
Stage 2	-	-	-	-	956
Platoon blocked, %	-	-	-	-	-
Mov Cap-1 Maneuver	-	-	1484	-	904
Mov Cap-2 Maneuver	-	-	-	-	904
Stage 1	-	-	-	-	998
Stage 2	-	-	-	-	955

Approach	EB	WB	NB
HCM Control Delay, s	0	0.1	9.4
HCM LOS			A

Minor Lane/Major Mvmt	NBLn1	NBLn2	EBT	EBR	WBL	WBT
Capacity (veh/h)	904	1050	-	-	1484	-
HCM Lane V/C Ratio	0.088	0.002	-	-	0.001	-
HCM Control Delay (s)	9.4	8.4	-	-	7.4	0
HCM Lane LOS	A	A	-	-	A	A
HCM 95th %tile Q(veh)	0.3	0	-	-	0	-

Intersection						
Int Delay, s/veh	2					
Movement	EBL	EBT	WBT	WBR	SBL	SBR
Lane Configurations	↘	↑↑	↑↑		↘	
Traffic Vol, veh/h	65	335	549	8	8	123
Future Vol, veh/h	65	335	549	8	8	123
Conflicting Peds, #/hr	0	0	0	0	0	0
Sign Control	Free	Free	Free	Free	Stop	Stop
RT Channelized	-	None	-	None	-	None
Storage Length	100	-	-	-	0	-
Veh in Median Storage, #	-	0	0	-	0	-
Grade, %	-	-1	1	-	2	-
Peak Hour Factor	96	96	96	96	96	96
Heavy Vehicles, %	2	11	2	2	2	2
Mvmt Flow	68	349	572	8	8	128

Major/Minor	Major1	Major2	Minor2		
Conflicting Flow All	580	0	-	0	887 290
Stage 1	-	-	-	-	576 -
Stage 2	-	-	-	-	311 -
Critical Hdwy	4.14	-	-	-	7.24 7.14
Critical Hdwy Stg 1	-	-	-	-	6.24 -
Critical Hdwy Stg 2	-	-	-	-	6.24 -
Follow-up Hdwy	2.22	-	-	-	3.52 3.32
Pot Cap-1 Maneuver	990	-	-	-	257 695
Stage 1	-	-	-	-	493 -
Stage 2	-	-	-	-	692 -
Platoon blocked, %		-	-	-	
Mov Cap-1 Maneuver	990	-	-	-	239 695
Mov Cap-2 Maneuver	-	-	-	-	239 -
Stage 1	-	-	-	-	459 -
Stage 2	-	-	-	-	692 -

Approach	EB	WB	SB
HCM Control Delay, s	1.4	0	12.4
HCM LOS			B

Minor Lane/Major Mvmt	EBL	EBT	WBT	WBR	SBLn1
Capacity (veh/h)	990	-	-	-	622
HCM Lane V/C Ratio	0.068	-	-	-	0.219
HCM Control Delay (s)	8.9	-	-	-	12.4
HCM Lane LOS	A	-	-	-	B
HCM 95th %tile Q(veh)	0.2	-	-	-	0.8

Intersection

Int Delay, s/veh 3

Movement	EBL	EBT	WBT	WBR	SBL	SBR
Lane Configurations		↕	↕		↕	
Traffic Vol, veh/h	12	15	70	0	0	34
Future Vol, veh/h	12	15	70	0	0	34
Conflicting Peds, #/hr	0	0	0	0	0	0
Sign Control	Free	Free	Free	Free	Stop	Stop
RT Channelized	-	None	-	None	-	None
Storage Length	-	-	-	-	0	-
Veh in Median Storage, #	-	0	0	-	0	-
Grade, %	-	-1	0	-	0	-
Peak Hour Factor	68	68	68	68	68	68
Heavy Vehicles, %	2	2	3	2	2	2
Mvmt Flow	18	22	103	0	0	50

Major/Minor	Major1	Major2	Minor2		
Conflicting Flow All	103	0	0	161	103
Stage 1	-	-	-	103	-
Stage 2	-	-	-	58	-
Critical Hdwy	4.12	-	-	6.42	6.22
Critical Hdwy Stg 1	-	-	-	5.42	-
Critical Hdwy Stg 2	-	-	-	5.42	-
Follow-up Hdwy	2.218	-	-	3.518	3.318
Pot Cap-1 Maneuver	1489	-	-	830	952
Stage 1	-	-	-	921	-
Stage 2	-	-	-	965	-
Platoon blocked, %		-	-		
Mov Cap-1 Maneuver	1489	-	-	820	952
Mov Cap-2 Maneuver	-	-	-	820	-
Stage 1	-	-	-	910	-
Stage 2	-	-	-	965	-

Approach	EB	WB	SB
HCM Control Delay, s	3.3	0	9
HCM LOS			A

Minor Lane/Major Mvmt	EBL	EBT	WBT	WBR	SBLn1
Capacity (veh/h)	1489	-	-	-	952
HCM Lane V/C Ratio	0.012	-	-	-	0.053
HCM Control Delay (s)	7.4	0	-	-	9
HCM Lane LOS	A	A	-	-	A
HCM 95th %tile Q(veh)	0	-	-	-	0.2

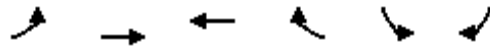

Lane Group	EBL	EBT	WBT	WBR	SBL	SBR
Lane Configurations						
Traffic Volume (vph)	241	356	604	1070	256	24
Future Volume (vph)	241	356	604	1070	256	24
Ideal Flow (vphpl)	1900	1900	1900	1900	1900	1900
Grade (%)		0%	-1%		0%	
Storage Length (ft)	220			0	125	125
Storage Lanes	1			1	2	0
Taper Length (ft)	25				25	
Satd. Flow (prot)	1787	1863	3592	1607	3502	1615
Flt Permitted	0.371				0.950	
Satd. Flow (perm)	698	1863	3592	1607	3502	1615
Right Turn on Red				Yes		Yes
Satd. Flow (RTOR)				806		25
Link Speed (mph)		25	25		25	
Link Distance (ft)		608	1114		279	
Travel Time (s)		16.6	30.4		7.6	
Peak Hour Factor	0.96	0.96	0.96	0.96	0.96	0.96
Heavy Vehicles (%)	1%	2%	1%	1%	0%	0%
Shared Lane Traffic (%)						
Lane Group Flow (vph)	251	371	629	1115	267	25
Turn Type	pm+pt	NA	NA	Free	Perm	Perm
Protected Phases	5	2	6			
Permitted Phases	2			Free	4	4
Total Split (s)	15.0	66.0	51.0		34.0	34.0
Total Lost Time (s)	3.0	6.0	6.0		6.0	6.0
Act Effct Green (s)	63.0	60.0	47.7	84.2	12.1	12.1
Actuated g/C Ratio	0.75	0.71	0.57	1.00	0.14	0.14
v/c Ratio	0.39	0.28	0.31	0.69	0.53	0.10
Control Delay	5.2	5.2	10.6	2.5	37.3	13.3
Queue Delay	0.0	0.0	0.0	0.0	0.0	0.0
Total Delay	5.2	5.2	10.6	2.5	37.3	13.3
LOS	A	A	B	A	D	B
Approach Delay		5.2	5.4		35.3	
Approach LOS		A	A		D	
Queue Length 50th (ft)	30	58	84	0	68	0
Queue Length 95th (ft)	60	106	137	0	105	21
Internal Link Dist (ft)		528	1034		199	
Turn Bay Length (ft)	220				125	125
Base Capacity (vph)	677	1328	2035	1607	1165	553
Starvation Cap Reductn	0	0	0	0	0	0
Spillback Cap Reductn	0	0	0	0	0	0
Storage Cap Reductn	0	0	0	0	0	0
Reduced v/c Ratio	0.37	0.28	0.31	0.69	0.23	0.05

Intersection Summary

Area Type: Other
 Cycle Length: 100
 Actuated Cycle Length: 84.2
 Control Type: Semi Act-Uncoord

Maximum v/c Ratio: 0.69

Intersection Signal Delay: 8.7

Intersection LOS: A

Intersection Capacity Utilization 72.5%

ICU Level of Service C

Analysis Period (min) 15

Splits and Phases: 10: Meadow Road & Route 1 SB Ramps



Lane Group	EBL	EBT	EBR	WBL	WBT	WBR	NBL	NBT	NBR	SBL	SBT	SBR
Lane Configurations												
Traffic Volume (vph)	74	410	129	122	787	113	158	38	122	237	22	729
Future Volume (vph)	74	410	129	122	787	113	158	38	122	237	22	729
Ideal Flow (vphpl)	1900	1900	1900	1900	1900	1900	1900	1900	1900	1900	1900	1900
Lane Width (ft)	12	12	12	12	12	12	12	11	11	13	13	16
Grade (%)		-5%			3%			3%			2%	
Storage Length (ft)	115		0	325		450	0		0	120		0
Storage Lanes	1		0	1		1	1		0	1		1
Taper Length (ft)	25			25			25			25		
Satd. Flow (prot)	1850	3532	0	1760	3556	1591	1760	1591	0	1828	1944	1794
Flt Permitted	0.285			0.377			0.482			0.755		
Satd. Flow (perm)	555	3532	0	699	3556	1591	893	1591	0	1453	1944	1794
Right Turn on Red			Yes			Yes			Yes			Yes
Satd. Flow (RTOR)		41				119		119				403
Link Speed (mph)		25			25			25				25
Link Distance (ft)		1114			682			434				429
Travel Time (s)		30.4			18.6			11.8				11.7
Peak Hour Factor	0.95	0.95	0.95	0.95	0.95	0.95	0.95	0.95	0.95	0.95	0.95	0.95
Heavy Vehicles (%)	0%	1%	1%	1%	0%	0%	1%	0%	1%	1%	0%	1%
Shared Lane Traffic (%)												
Lane Group Flow (vph)	78	568	0	128	828	119	166	168	0	249	23	767
Turn Type	pm+pt	NA		pm+pt	NA	Perm	pm+pt	NA		pm+pt	NA	Free
Protected Phases	5	2		1	6		3	8		7	4	
Permitted Phases	2			6		6	8			4		Free
Total Split (s)	15.0	59.0		15.0	59.0	59.0	16.0	36.0		16.0	36.0	
Total Lost Time (s)	3.0	6.0		3.0	6.0	6.0	3.0	7.0		3.0	7.0	
Act Effct Green (s)	63.6	53.1		66.6	56.2	56.2	30.4	11.5		19.9	11.5	105.4
Actuated g/C Ratio	0.60	0.50		0.63	0.53	0.53	0.29	0.11		0.19	0.11	1.00
v/c Ratio	0.18	0.32		0.24	0.44	0.13	0.37	0.60		0.78	0.11	0.43
Control Delay	8.5	15.2		8.7	16.7	3.1	31.5	24.9		54.9	43.7	0.7
Queue Delay	0.0	0.0		0.0	0.0	0.0	0.0	0.0		0.0	0.0	0.0
Total Delay	8.5	15.2		8.7	16.7	3.1	31.5	24.9		54.9	43.7	0.7
LOS	A	B		A	B	A	C	C		D	D	A
Approach Delay		14.4			14.2			28.2			14.7	
Approach LOS		B			B			C			B	
Queue Length 50th (ft)	17	101		29	171	0	86	31		~186	14	0
Queue Length 95th (ft)	39	162		60	255	30	147	100		216	40	0
Internal Link Dist (ft)		1034			602			354			349	
Turn Bay Length (ft)	115			325		450				120		
Base Capacity (vph)	502	1799		570	1897	904	450	524		320	535	1794
Starvation Cap Reductn	0	0		0	0	0	0	0		0	0	0
Spillback Cap Reductn	0	0		0	0	0	0	0		0	0	0
Storage Cap Reductn	0	0		0	0	0	0	0		0	0	0
Reduced v/c Ratio	0.16	0.32		0.22	0.44	0.13	0.37	0.32		0.78	0.04	0.43
Intersection Summary												
Area Type:	Other											
Cycle Length:	126											
Actuated Cycle Length:	105.4											

Control Type: Semi Act-Uncoord

Maximum v/c Ratio: 0.78

Intersection Signal Delay: 15.9

Intersection LOS: B

Intersection Capacity Utilization 91.1%









ICU Level of Service F

Analysis Period (min) 15

~ Volume exceeds capacity, queue is theoretically infinite.

Queue shown is maximum after two cycles.

Splits and Phases: 20: Old Meadow Rd/Route 1 NB Ramps & Meadow Road

 Ø1	 Ø2	 Ø3	 Ø4
15 s	59 s	16 s	36 s
 Ø5	 Ø6	 Ø7	 Ø8
15 s	59 s	16 s	36 s

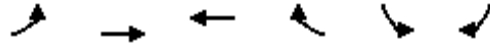

Lane Group	EBL	EBT	WBT	WBR	SBL	SBR
Lane Configurations						
Traffic Volume (vph)	301	588	208	80	123	155
Future Volume (vph)	301	588	208	80	123	155
Ideal Flow (vphpl)	1900	1900	1900	1900	1900	1900
Lane Width (ft)	12	12	11	13	11	11
Grade (%)		1%	0%		0%	
Storage Length (ft)	190			155	265	0
Storage Lanes	1			1	1	1
Taper Length (ft)	25				25	
Satd. Flow (prot)	1778	1872	1801	1652	1745	1561
Flt Permitted	0.615				0.950	
Satd. Flow (perm)	1151	1872	1801	1652	1745	1561
Right Turn on Red				Yes		Yes
Satd. Flow (RTOR)						172
Link Speed (mph)		25	25		25	
Link Distance (ft)		2245	457		697	
Travel Time (s)		61.2	12.5		19.0	
Peak Hour Factor	0.90	0.90	0.90	0.90	0.90	0.90
Heavy Vehicles (%)	1%	1%	2%	1%	0%	0%
Shared Lane Traffic (%)						
Lane Group Flow (vph)	334	653	231	89	137	172
Turn Type	Perm	NA	NA	pm+ov	Prot	Prot
Protected Phases		2	6	4	4	8
Permitted Phases	2			6		
Total Split (s)	55.0	55.0	55.0	35.0	35.0	35.0
Total Lost Time (s)	5.0	5.0	5.0	5.0	5.0	5.0
Act Effct Green (s)	50.1	50.1	50.1	71.2	11.1	11.1
Actuated g/C Ratio	0.70	0.70	0.70	1.00	0.16	0.16
v/c Ratio	0.41	0.50	0.18	0.05	0.50	0.44
Control Delay	6.8	6.9	4.4	0.1	34.1	8.6
Queue Delay	0.0	0.0	0.0	0.0	0.0	0.0
Total Delay	6.8	6.9	4.4	0.1	34.1	8.6
LOS	A	A	A	A	C	A
Approach Delay		6.8	3.2		19.9	
Approach LOS		A	A		B	
Queue Length 50th (ft)	50	105	28	0	56	0
Queue Length 95th (ft)	114	209	61	0	106	47
Internal Link Dist (ft)		2165	377		617	
Turn Bay Length (ft)	190			155	265	
Base Capacity (vph)	809	1316	1266	1652	736	758
Starvation Cap Reductn	0	0	0	0	0	0
Spillback Cap Reductn	0	0	0	0	0	0
Storage Cap Reductn	0	0	0	0	0	0
Reduced v/c Ratio	0.41	0.50	0.18	0.05	0.19	0.23

Intersection Summary

Area Type: Other

Cycle Length: 90

Actuated Cycle Length: 71.2

Control Type: Semi Act-Uncoord

Maximum v/c Ratio: 0.50

Intersection Signal Delay: 8.6

Intersection LOS: A

Intersection Capacity Utilization 102.6%

ICU Level of Service G

Analysis Period (min) 15

Splits and Phases: 40: Meadow Road & Bear Brook Road

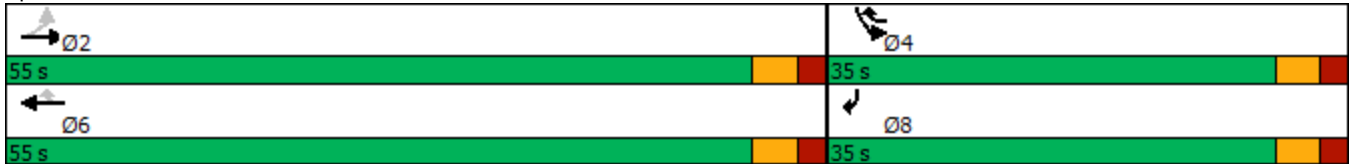

Intersection

Int Delay, s/veh 4

Movement	EBT	EBR	WBL	WBT	NBL	NBR
Lane Configurations	↑			↑		↑
Traffic Vol, veh/h	75	0	0	101	0	130
Future Vol, veh/h	75	0	0	101	0	130
Conflicting Peds, #/hr	0	0	0	0	0	0
Sign Control	Free	Free	Free	Free	Stop	Stop
RT Channelized	-	None	-	None	-	Yield
Storage Length	-	-	-	-	-	0
Veh in Median Storage, #	0	-	-	0	0	-
Grade, %	0	-	-	0	0	-
Peak Hour Factor	90	90	90	90	90	90
Heavy Vehicles, %	2	2	2	2	2	2
Mvmt Flow	83	0	0	112	0	144

Major/Minor	Major1	Major2	Minor1
Conflicting Flow All	0	-	-
Stage 1	-	-	-
Stage 2	-	-	-
Critical Hdwy	-	-	-
Critical Hdwy Stg 1	-	-	-
Critical Hdwy Stg 2	-	-	-
Follow-up Hdwy	-	-	-
Pot Cap-1 Maneuver	-	0	0
Stage 1	-	0	0
Stage 2	-	0	0
Platoon blocked, %	-	-	-
Mov Cap-1 Maneuver	-	-	-
Mov Cap-2 Maneuver	-	-	-
Stage 1	-	-	-
Stage 2	-	-	-

Approach	EB	WB	NB
HCM Control Delay, s	0	0	9.3
HCM LOS			A

Minor Lane/Major Mvmt	NBLn1	EBT	WBT
Capacity (veh/h)	976	-	-
HCM Lane V/C Ratio	0.148	-	-
HCM Control Delay (s)	9.3	-	-
HCM Lane LOS	A	-	-
HCM 95th %tile Q(veh)	0.5	-	-

Intersection								
Intersection Delay, s/veh	9.8							
Intersection LOS	A							
Approach	EB		WB		NB		SB	
Entry Lanes	2		2		1		2	
Conflicting Circle Lanes	1		1		1		1	
Adj Approach Flow, veh/h	721		385		33		916	
Demand Flow Rate, veh/h	727		385		33		916	
Vehicles Circulating, veh/h	302		58		977		388	
Vehicles Exiting, veh/h	1002		952		52		55	
Ped Vol Crossing Leg, #/h	0		0		0		0	
Ped Cap Adj	1.000		1.000		1.000		1.000	
Approach Delay, s/veh	11.6		4.9		7.9		10.6	
Approach LOS	B		A		A		B	
Lane	Left	Right	Left	Right	Left	Left	Right	
Designated Moves	LT	R	LT	R	LTR	LT	R	
Assumed Moves	LT	R	LT	R	LTR	LT	R	
RT Channelized								
Lane Util	0.938	0.062	0.938	0.062	1.000	0.322	0.678	
Follow-Up Headway, s	2.535	2.535	2.535	2.535	2.609	2.535	2.535	
Critical Headway, s	4.544	4.544	4.544	4.544	4.976	4.544	4.544	
Entry Flow, veh/h	682	45	361	24	33	295	621	
Cap Entry Lane, veh/h	1079	1079	1347	1347	509	998	998	
Entry HV Adj Factor	0.991	1.000	1.000	1.000	1.000	1.000	1.000	
Flow Entry, veh/h	676	45	361	24	33	295	621	
Cap Entry, veh/h	1069	1079	1347	1347	509	998	998	
V/C Ratio	0.632	0.042	0.268	0.018	0.065	0.296	0.622	
Control Delay, s/veh	12.1	3.7	5.0	2.8	7.9	6.6	12.5	
LOS	B	A	A	A	A	A	B	
95th %tile Queue, veh	5	0	1	0	0	1	5	

Intersection

Int Delay, s/veh	7.9					
Movement	EBL	EBR	NBL	NBT	SBT	SBR
Lane Configurations						
Traffic Vol, veh/h	46	252	24	28	609	23
Future Vol, veh/h	46	252	24	28	609	23
Conflicting Peds, #/hr	0	0	0	0	0	0
Sign Control	Stop	Stop	Free	Free	Free	Free
RT Channelized	-	None	-	None	-	None
Storage Length	100	0	0	-	-	-
Veh in Median Storage, #	0	-	-	0	0	-
Grade, %	1	-	-	-2	1	-
Peak Hour Factor	90	90	90	90	90	90
Heavy Vehicles, %	2	1	0	0	0	5
Mvmt Flow	51	280	27	31	677	26

Major/Minor	Minor2	Major1	Major2			
Conflicting Flow All	775	690	703	0	-	0
Stage 1	690	-	-	-	-	-
Stage 2	85	-	-	-	-	-
Critical Hdwy	6.62	6.31	4.1	-	-	-
Critical Hdwy Stg 1	5.62	-	-	-	-	-
Critical Hdwy Stg 2	5.62	-	-	-	-	-
Follow-up Hdwy	3.518	3.309	2.2	-	-	-
Pot Cap-1 Maneuver	351	438	904	-	-	-
Stage 1	479	-	-	-	-	-
Stage 2	934	-	-	-	-	-
Platoon blocked, %				-	-	-
Mov Cap-1 Maneuver	340	438	904	-	-	-
Mov Cap-2 Maneuver	340	-	-	-	-	-
Stage 1	465	-	-	-	-	-
Stage 2	934	-	-	-	-	-

Approach	EB	NB	SB
HCM Control Delay, s	25.3	4.2	0
HCM LOS	D		

Minor Lane/Major Mvmt	NBL	NBT	EBLn1	EBLn2	SBT	SBR
Capacity (veh/h)	904	-	340	438	-	-
HCM Lane V/C Ratio	0.029	-	0.15	0.639	-	-
HCM Control Delay (s)	9.1	-	17.5	26.7	-	-
HCM Lane LOS	A	-	C	D	-	-
HCM 95th %tile Q(veh)	0.1	-	0.5	4.4	-	-

Intersection												
Int Delay, s/veh	1.8											
Movement	EBL	EBT	EBR	WBL	WBT	WBR	NBL	NBT	NBR	SBL	SBT	SBR
Lane Configurations	↖	↗		↖	↗			↕			↕	
Traffic Vol, veh/h	11	241	0	2	50	10	0	0	2	35	0	16
Future Vol, veh/h	11	241	0	2	50	10	0	0	2	35	0	16
Conflicting Peds, #/hr	0	0	0	0	0	0	0	0	0	0	0	0
Sign Control	Free	Free	Free	Free	Free	Free	Stop	Stop	Stop	Stop	Stop	Stop
RT Channelized	-	-	None	-	-	None	-	-	None	-	-	None
Storage Length	125	-	-	125	-	-	-	-	-	-	-	-
Veh in Median Storage, #	-	0	-	-	0	-	-	0	-	-	0	-
Grade, %	-	-1	-	-	1	-	-	-1	-	-	0	-
Peak Hour Factor	90	90	90	90	90	90	90	90	90	90	90	90
Heavy Vehicles, %	9	2	0	0	0	10	0	0	0	3	0	0
Mvmt Flow	12	268	0	2	56	11	0	0	2	39	0	18

Major/Minor	Major1		Major2		Minor1		Minor2					
Conflicting Flow All	67	0	0	268	0	0	367	363	268	359	358	62
Stage 1	-	-	-	-	-	-	292	292	-	66	66	-
Stage 2	-	-	-	-	-	-	75	71	-	293	292	-
Critical Hdwy	4.19	-	-	4.1	-	-	6.9	6.3	6.1	7.13	6.5	6.2
Critical Hdwy Stg 1	-	-	-	-	-	-	5.9	5.3	-	6.13	5.5	-
Critical Hdwy Stg 2	-	-	-	-	-	-	5.9	5.3	-	6.13	5.5	-
Follow-up Hdwy	2.281	-	-	2.2	-	-	3.5	4	3.3	3.527	4	3.3
Pot Cap-1 Maneuver	1491	-	-	1307	-	-	605	579	781	595	572	1009
Stage 1	-	-	-	-	-	-	732	686	-	942	844	-
Stage 2	-	-	-	-	-	-	943	843	-	713	675	-
Platoon blocked, %	-	-	-	-	-	-	-	-	-	-	-	-
Mov Cap-1 Maneuver	1491	-	-	1307	-	-	590	573	781	589	566	1009
Mov Cap-2 Maneuver	-	-	-	-	-	-	590	573	-	589	566	-
Stage 1	-	-	-	-	-	-	726	681	-	934	842	-
Stage 2	-	-	-	-	-	-	925	841	-	705	670	-

Approach	EB		WB		NB		SB	
HCM Control Delay, s	0.3		0.3		9.6		10.8	
HCM LOS					A		B	

Minor Lane/Major Mvmt	NBLn1	EBL	EBT	EBR	WBL	WBT	WBR	SBLn1
Capacity (veh/h)	781	1491	-	-	1307	-	-	677
HCM Lane V/C Ratio	0.003	0.008	-	-	0.002	-	-	0.084
HCM Control Delay (s)	9.6	7.4	-	-	7.8	-	-	10.8
HCM Lane LOS	A	A	-	-	A	-	-	B
HCM 95th %tile Q(veh)	0	0	-	-	0	-	-	0.3

Intersection

Int Delay, s/veh 0.7

Movement	EBL	EBT	WBT	WBR	SBL	SBR
Lane Configurations						
Traffic Vol, veh/h	2	236	52	12	18	1
Future Vol, veh/h	2	236	52	12	18	1
Conflicting Peds, #/hr	0	0	0	0	0	0
Sign Control	Free	Free	Free	Free	Stop	Stop
RT Channelized	-	None	-	None	-	None
Storage Length	125	-	-	-	0	-
Veh in Median Storage, #	-	0	0	-	0	-
Grade, %	-	-1	1	-	0	-
Peak Hour Factor	90	90	90	90	90	90
Heavy Vehicles, %	0	0	0	0	0	0
Mvmt Flow	2	262	58	13	20	1

Major/Minor	Major1	Major2	Minor2		
Conflicting Flow All	71	0	-	0	331 65
Stage 1	-	-	-	-	65 -
Stage 2	-	-	-	-	266 -
Critical Hdwy	4.1	-	-	-	6.4 6.2
Critical Hdwy Stg 1	-	-	-	-	5.4 -
Critical Hdwy Stg 2	-	-	-	-	5.4 -
Follow-up Hdwy	2.2	-	-	-	3.5 3.3
Pot Cap-1 Maneuver	1542	-	-	-	668 1005
Stage 1	-	-	-	-	963 -
Stage 2	-	-	-	-	783 -
Platoon blocked, %		-	-	-	
Mov Cap-1 Maneuver	1542	-	-	-	667 1005
Mov Cap-2 Maneuver	-	-	-	-	667 -
Stage 1	-	-	-	-	962 -
Stage 2	-	-	-	-	783 -

Approach	EB	WB	SB
HCM Control Delay, s	0.1	0	10.5
HCM LOS			B

Minor Lane/Major Mvmt	EBL	EBT	WBT	WBR	SBLn1
Capacity (veh/h)	1542	-	-	-	679
HCM Lane V/C Ratio	0.001	-	-	-	0.031
HCM Control Delay (s)	7.3	-	-	-	10.5
HCM Lane LOS	A	-	-	-	B
HCM 95th %tile Q(veh)	0	-	-	-	0.1

Intersection

Int Delay, s/veh 4.1

Movement	EBL	EBT	EBR	WBL	WBT	WBR	NBL	NBT	NBR	SBL	SBT	SBR
Lane Configurations	↖	↗		↖	↗			↕			↕	
Traffic Vol, veh/h	8	155	41	8	42	4	8	0	6	76	0	51
Future Vol, veh/h	8	155	41	8	42	4	8	0	6	76	0	51
Conflicting Peds, #/hr	0	0	0	0	0	0	0	0	0	0	0	0
Sign Control	Free	Free	Free	Free	Free	Free	Stop	Stop	Stop	Stop	Stop	Stop
RT Channelized	-	-	None	-	-	None	-	-	None	-	-	None
Storage Length	125	-	-	125	-	-	-	-	-	-	-	-
Veh in Median Storage, #	-	0	-	-	0	-	-	0	-	-	0	-
Grade, %	-	-1	-	-	1	-	-	1	-	-	-1	-
Peak Hour Factor	90	90	90	90	90	90	90	90	90	90	90	90
Heavy Vehicles, %	13	2	2	0	0	0	2	0	0	0	0	2
Mvmt Flow	9	172	46	9	47	4	9	0	7	84	0	57

Major/Minor	Major1	Major2	Minor1	Minor2
Conflicting Flow All	51	0	0	218
Stage 1	-	-	-	-
Stage 2	-	-	-	-
Critical Hdwy	4.23	-	-	4.1
Critical Hdwy Stg 1	-	-	-	-
Critical Hdwy Stg 2	-	-	-	-
Follow-up Hdwy	2.317	-	-	2.2
Pot Cap-1 Maneuver	1488	-	-	1364
Stage 1	-	-	-	-
Stage 2	-	-	-	-
Platoon blocked, %	-	-	-	-
Mov Cap-1 Maneuver	1488	-	-	1364
Mov Cap-2 Maneuver	-	-	-	-
Stage 1	-	-	-	-
Stage 2	-	-	-	-

Approach	EB	WB	NB	SB
HCM Control Delay, s	0.3	1.1	10.4	10.7
HCM LOS			B	B

Minor Lane/Major Mvmt	NBLn1	EBL	EBT	EBR	WBL	WBT	WBR	SBLn1
Capacity (veh/h)	680	1488	-	-	1364	-	-	778
HCM Lane V/C Ratio	0.023	0.006	-	-	0.007	-	-	0.181
HCM Control Delay (s)	10.4	7.4	-	-	7.7	-	-	10.7
HCM Lane LOS	B	A	-	-	A	-	-	B
HCM 95th %tile Q(veh)	0.1	0	-	-	0	-	-	0.7

Intersection

Int Delay, s/veh 4.8

Movement	EBT	EBR	WBL	WBT	NBL	NBR
Lane Configurations	↑	↗		↖↑	↖	↗
Traffic Vol, veh/h	79	194	3	65	253	14
Future Vol, veh/h	79	194	3	65	253	14
Conflicting Peds, #/hr	0	0	0	0	0	0
Sign Control	Free	Free	Free	Free	Stop	Stop
RT Channelized	-	None	-	None	-	None
Storage Length	-	0	-	-	140	0
Veh in Median Storage, #	0	-	-	0	0	-
Grade, %	-2	-	-	1	0	-
Peak Hour Factor	94	94	94	94	94	94
Heavy Vehicles, %	2	0	0	3	0	0
Mvmt Flow	84	206	3	69	269	15

Major/Minor	Major1	Major2	Minor1
Conflicting Flow All	0	0	290
Stage 1	-	-	-
Stage 2	-	-	-
Critical Hdwy	-	-	4.1
Critical Hdwy Stg 1	-	-	-
Critical Hdwy Stg 2	-	-	-
Follow-up Hdwy	-	-	2.2
Pot Cap-1 Maneuver	-	-	1283
Stage 1	-	-	-
Stage 2	-	-	-
Platoon blocked, %	-	-	-
Mov Cap-1 Maneuver	-	-	1283
Mov Cap-2 Maneuver	-	-	-
Stage 1	-	-	-
Stage 2	-	-	-

Approach	EB	WB	NB
HCM Control Delay, s	0	0.3	10.9
HCM LOS			B

Minor Lane/Major Mvmt	NBLn1	NBLn2	EBT	EBR	WBL	WBT
Capacity (veh/h)	867	981	-	-	1283	-
HCM Lane V/C Ratio	0.31	0.015	-	-	0.002	-
HCM Control Delay (s)	11	8.7	-	-	7.8	0
HCM Lane LOS	B	A	-	-	A	A
HCM 95th %tile Q(veh)	1.3	0	-	-	0	-

Intersection						
Int Delay, s/veh	2.9					
Movement	EBL	EBT	WBT	WBR	SBL	SBR
Lane Configurations						
Traffic Vol, veh/h	111	658	913	28	19	108
Future Vol, veh/h	111	658	913	28	19	108
Conflicting Peds, #/hr	0	0	0	0	0	0
Sign Control	Free	Free	Free	Free	Stop	Stop
RT Channelized	-	None	-	None	-	None
Storage Length	100	-	-	-	0	-
Veh in Median Storage, #	-	0	0	-	0	-
Grade, %	-	-1	1	-	2	-
Peak Hour Factor	94	94	94	94	94	94
Heavy Vehicles, %	2	5	1	2	2	2
Mvmt Flow	118	700	971	30	20	115

Major/Minor	Major1	Major2	Minor2
Conflicting Flow All	1001	0	0
Stage 1	-	-	-
Stage 2	-	-	-
Critical Hdwy	4.14	-	-
Critical Hdwy Stg 1	-	-	-
Critical Hdwy Stg 2	-	-	-
Follow-up Hdwy	2.22	-	-
Pot Cap-1 Maneuver	687	-	-
Stage 1	-	-	-
Stage 2	-	-	-
Platoon blocked, %	-	-	-
Mov Cap-1 Maneuver	687	-	-
Mov Cap-2 Maneuver	-	-	-
Stage 1	-	-	-
Stage 2	-	-	-

Approach	EB	WB	SB
HCM Control Delay, s	1.6	0	32.7
HCM LOS			D

Minor Lane/Major Mvmt	EBL	EBT	WBT	WBR	SBLn1
Capacity (veh/h)	687	-	-	-	261
HCM Lane V/C Ratio	0.172	-	-	-	0.518
HCM Control Delay (s)	11.3	-	-	-	32.7
HCM Lane LOS	B	-	-	-	D
HCM 95th %tile Q(veh)	0.6	-	-	-	2.7

Intersection

Int Delay, s/veh 2.6

Movement	EBL	EBT	WBT	WBR	SBL	SBR
Lane Configurations		↕	↕		↕	
Traffic Vol, veh/h	32	60	48	0	0	20
Future Vol, veh/h	32	60	48	0	0	20
Conflicting Peds, #/hr	0	0	0	0	0	0
Sign Control	Free	Free	Free	Free	Stop	Stop
RT Channelized	-	None	-	None	-	None
Storage Length	-	-	-	-	0	-
Veh in Median Storage, #	-	0	0	-	0	-
Grade, %	-	-1	0	-	0	-
Peak Hour Factor	83	83	83	83	83	83
Heavy Vehicles, %	2	1	1	2	2	2
Mvmt Flow	39	72	58	0	0	24

Major/Minor	Major1	Major2	Minor2		
Conflicting Flow All	58	0	-	0	208 58
Stage 1	-	-	-	-	58 -
Stage 2	-	-	-	-	150 -
Critical Hdwy	4.12	-	-	-	6.42 6.22
Critical Hdwy Stg 1	-	-	-	-	5.42 -
Critical Hdwy Stg 2	-	-	-	-	5.42 -
Follow-up Hdwy	2.218	-	-	-	3.518 3.318
Pot Cap-1 Maneuver	1546	-	-	-	780 1008
Stage 1	-	-	-	-	965 -
Stage 2	-	-	-	-	878 -
Platoon blocked, %		-	-	-	
Mov Cap-1 Maneuver	1546	-	-	-	760 1008
Mov Cap-2 Maneuver	-	-	-	-	760 -
Stage 1	-	-	-	-	940 -
Stage 2	-	-	-	-	878 -

Approach	EB	WB	SB
HCM Control Delay, s	2.6	0	8.7
HCM LOS			A

Minor Lane/Major Mvmt	EBL	EBT	WBT	WBR	SBLn1
Capacity (veh/h)	1546	-	-	-	1008
HCM Lane V/C Ratio	0.025	-	-	-	0.024
HCM Control Delay (s)	7.4	0	-	-	8.7
HCM Lane LOS	A	A	-	-	A
HCM 95th %tile Q(veh)	0.1	-	-	-	0.1

Appendix D
Internal Capture Worksheets

Land Use	Trip Type	AM PSH			PM PSH		
		In	Out	Total	In	Out	Total
Hotel	Total	36	25	61	40	38	78
	Internal	1	2	3	9	3	12
	Passby	0	0	0	0	0	0
	New (Primary)	35	23	58	31	35	66
Retail	Total	9	6	15	67	73	140
	Internal	3	2	5	19	35	54
	Passby	0	0	0	15	15	30
	New (Primary)	6	4	10	33	23	56
Restaurant	Total	38	31	69	42	26	68
	Internal	11	3	14	20	18	38
	Passby	0	0	0	6	6	12
	New (Primary)	27	28	55	16	2	18
North Residential	Total	33	95	128	96	61	157
	Internal-*	1	6	7	14	9	23
	Passby	0	0	0	0	0	0
	New (Primary)	32	89	121	82	52	134
South Residential	Total	28	80	108	81	51	132
	Internal-*	1	4	5	10	7	17
	Passby	0	0	0	0	0	0
	New (Primary)	27	76	103	71	44	115
Total	Total	144	237	381	326	249	575
	Internal-*	17	17	34	72	72	144
	Passby	0	0	0	21	21	42
	New (Primary)	127	220	347	233	156	389

*- North and South were Divided Proportionate to the Number of Units (54/46)

**MULTI-USE DEVELOPMENT TRIP
GENERATION AND INTERNAL CAPTURE
SUMMARY**

Analyst: **CWP**
Date: **10/15/2019**

Name of Development: **West Windsor**
Time Period: **Weekday AM Peak Hour**

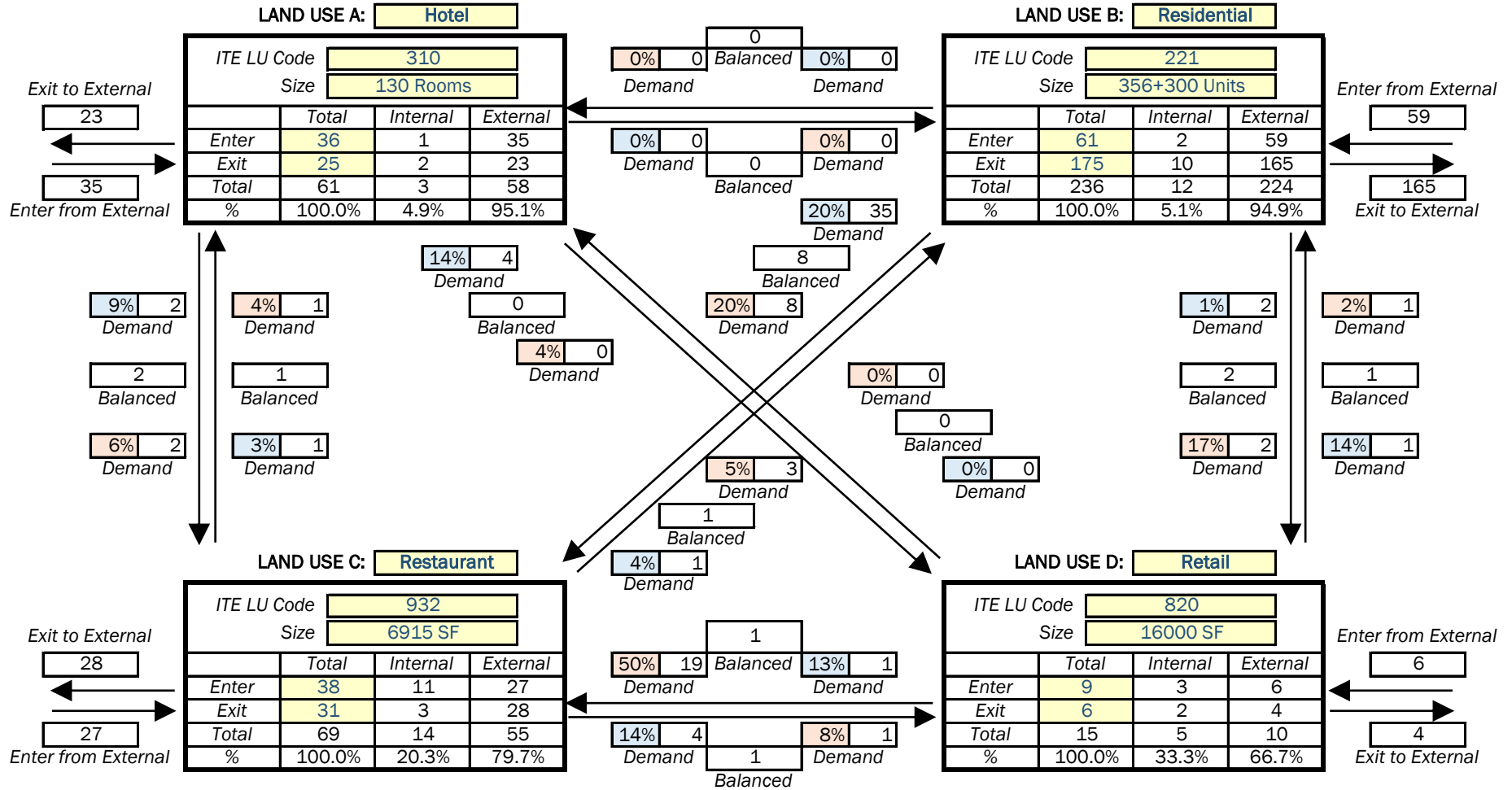

Net External Trips for Mult-Use Development					
	Land Use A	Land Use B	Land Use C	Land Use D	Total
Enter	35	59	27	6	127
Exit	23	165	28	4	220
Total	58	224	55	10	347
Single Use Trip Gen Est.	61	236	69	15	381
					Internal Capture
					8.9%

Note: Internal capture rates obtained from ITE publications *Trip Generation Handbook, 3rd Edition* and *Trip Generation Handbook, 2nd Edition*

**MULTI-USE DEVELOPMENT TRIP
GENERATION AND INTERNAL CAPTURE
SUMMARY**

Analyst: **CWP**
Date: **10/15/2019**

Name of Development: **West Windsor**
Time Period: **Weekday PM Peak Hour**

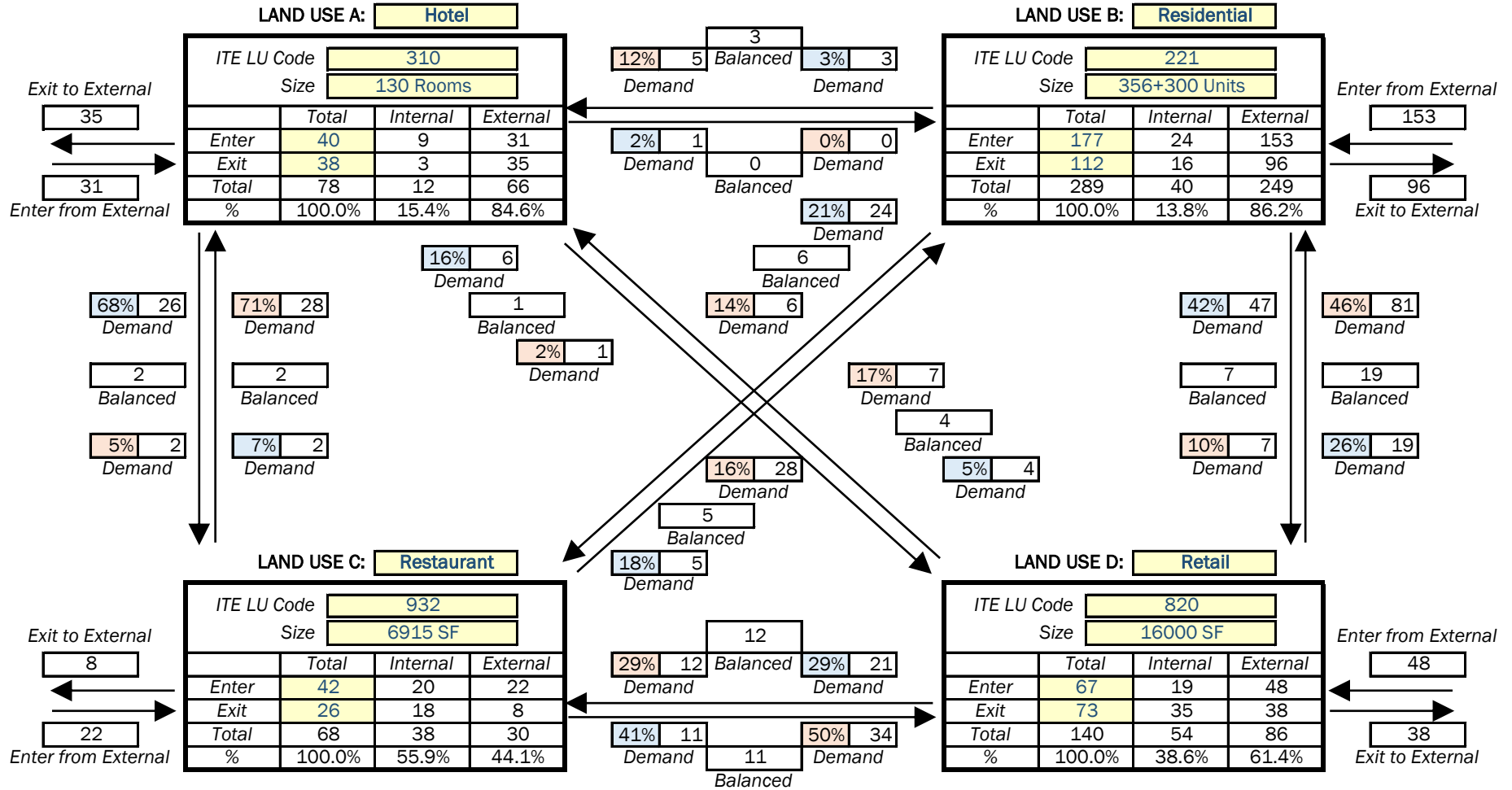

Net External Trips for Mult-Use Development						
	Land Use A	Land Use B	Land Use C	Land Use D	Total	
Enter	31	153	22	48	254	
Exit	35	96	8	38	177	
Total	66	249	30	86	431	
Single Use Trip Gen Est.	78	289	68	140	575	
						Internal Capture 25.0%

Note: Internal capture rates obtained from ITE publications *Trip Generation Handbook, 3rd Edition* and *Trip Generation Handbook, 2nd Edition*